



SHARP®

NOTEBOOK COMPUTER

PC-GP2 Series

OPERATION MANUAL

Notice for Users in the UK and Ireland

The mains lead of this product is fitted with a non-rewireable (moulded) plug incorporating a 3A fuse. Should the fuse need to be replaced, a BSI or ASTA approved BS 1362 fuse marked  or  and of the same rating as above; which is also indicated on the pin face of the plug must be used.

Always refit the fuse cover after replacing the fuse. Never use the plug without the fuse cover fitted.

In the unlikely event of the socket outlet in your home not being compatible with the plug supplied, cut-off the mains plug and fit an appropriate type.

DANGER:

The fuse from the cut-off plug should be removed and the cut-off plug destroyed immediately and disposed of in a safe manner.

Under no circumstances should the cut-off plug be inserted elsewhere into a 13A socket outlet as a serious electric shock may occur.

To fit an appropriate plug to the mains lead, follow the instructions below:

IMPORTANT:

The wires in the mains lead are coloured in accordance with the following code:

Blue: Neutral

Brown: Live

As the colours of the wires in the mains lead of this product may not correspond with the coloured markings identifying the terminals in your plug, proceed as follows:

- The wire which is coloured blue must be connected to the plug terminal which is marked N or coloured black.
- The wire which is coloured brown must be connected to the plug terminal which is marked L or coloured red.

Ensure that neither the brown nor the blue wire is connected to the earth terminal in your three pin plug.

Before replacing the plug cover, make sure that:

- If the new fitted plug contains a fuse, Its value is the same as that removed from the cut-off plug.
- The cord grip is clamped over the sheath of the mains lead and not simply over the lead wires.

IF YOU HAVE ANY DOUBT, CONSULT A QUALIFIED ELECTRICIAN.

Copyright

Recording and playback of any material may require consent, which SHARP is unable to give. Please refer particularly to the provisions of the Copyright Act 1956, the Dramatic and Musical Performers Protection Act 1958, the Performers Protection Acts 1963 and 1972 and to any subsequent statutory enactments and orders.

Notice for Users in Europe

About the Modem

Your Sharp PC-GP series with integral modem has been designed to work with the analogue PSTN's in the following countries:

- United Kingdom
- Ireland
- Italy
- Germany
- Switzerland

If you wish to connect the equipment to the PSTN in a country not listed above, you should contact your equipment supplier for further details.

The modem is not designed for use on a shared service line or a line equipped with a call waiting facility. If you attempt to use the modem on a telephone line with call waiting, you may experience communication errors.

To maintain CTR21 network compatibility when used in the countries listed above the following setting should be observed:

Pulse dial may not be available in some countries.

Modem Model Name: V1456VQL-P1(INT)

Intended Use

This is a Personal Computer with Modem for the analogue PSTN network which operates in all UK, Irish, Italian, German, Swiss networks which follow the CTR21 Standard.

If you are in doubt whether your network follows the CTR21, please contact your dealer or network operator.

This equipment complies with the requirements of the Directive 1999/5/EC.

Dieses Gerät entspricht den Anforderungen der EU-Richtlinie 1999/5/EG.

Cet appareil est conforme aux exigences de la directive 1999/5/CE.

Este aparato satisface las exigencias de las Directiva 1999/5/CE.

Quest'apparecchio è conforme ai requisiti delle direttiva 1999/5/CE.

Dit apparaat voldoet aan de eisen van de richtlijn 1999/5/EG.

Este equipamento obedece às exigências da directiva 1999/5/CE.

Η συσκευή αυτή ανταποκρίνεται στις απαιτήσεις των οδηγιών 1999/5/ΕΚ.

Denna utrustning uppfyller kraven enligt direktiv 1999/5/EC.

Dette udstyr overholder kravene i direktiv 1999/5/EF.

Dette produktet oppfyller kravene i direktiv 1999/5/EC.

Tämä laite täyttää direktiivi 1999/5/EY.

CAUTION:

TO PREVENT ELECTRICAL SHOCK, DISCONNECT THE AC CORD AND THE BATTERY BEFORE SERVICING.

CAUTION:

FOR A COMPLETE ELECTRICAL DISCONNECTION, PULL OUT THE MAIN PLUG AND THE BATTERY.

VORSICHT:

UM DIE STROMZUFUHR VOLLSTÄNDIG ZU UNTERBRECHEN, DEN NETZSTECKER HERAUSZIEHEN UND DIE BATTERIE ÈNTFERNEN.

ATTENTION:

POUR UN ARRET TOTAL DU SYSTEME, DECONNECTEZ LA PRISE DE COURANT SECTEUR ET LA BATTERIE.

VARNING:

FÖR TOTAL ELEKTRISK URKOPPLING, KOPPLA UR KONTAKTEN OCH TA UR BATTERIET.

PRECAUCION:

PARA UNA COMPLETA DESCONEXION ELECTRICA DESENCHUFE LA CLAVIJA DE LA RED Y LA BATERIA.

Safety Precautions

General

- Follow all cautions and instructions, which may be marked, on the computer.
- Except as described elsewhere in this manual, refer all servicing to qualified personnel. Immediately shut off the computer and seek servicing under the following conditions:
 - when the power cord or plug is damaged or frayed
 - if liquid has been spilled on the computer
 - if the computer has been dropped or the cabinet has been damaged

Location

- Do not expose the computer to direct sunlight.
- Try to avoid dusty environments.
- Keep the computer away from any magnetic devices and TVs.
- Keep the computer away from excessive humidity or fluids such as rain, snow, water spray, juice, coffee, steam, etc.
- Do not move the computer from an extremely cold place to an extremely warm place. A temperature difference of more than 10°C (18°F) will cause condensation inside the unit, which may cause damage.
- Do not block or cover slots or openings on the cabinet. These protect the computer from overheating.
- Care should be exercised when using on heat sensitive surfaces or your lap as the base of this computer will get hot.

Usage

- Never push any objects of any kind into cabinet openings. They may touch dangerous voltage points or short parts that could result in fire or electrical shock.
- Turn off the computer before installing or removing any peripheral devices except when connecting USB devices, IEEE 1394 devices, and PC cards. (Also, you do not have to turn off the computer before inserting/ejecting SD cards and smart media cards).
- Check the AC power cord and power connectors periodically for damage. Replace the power cord immediately if damage is found.

- Never subject your computer to sudden shocks or extreme vibration.
- Do not drop the computer nor hit it with other equipment.
- Do not scratch the surface of the LCD screen.
- Turn off the computer and disconnect the AC power cord before cleaning.

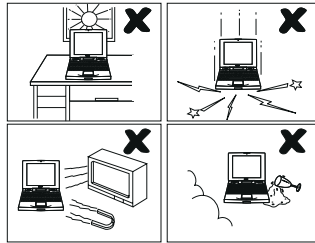

Battery Pack Precautions

CAUTION

DANGER OF EXPLOSION IF BATTERY IS INCORRECTLY REPLACED. REPLACE ONLY WITH THE SAME OR EQUIVALENT TYPE RECOMMENDED BY THE MANUFACTURER. DISCARD USED BATTERIES ACCORDING TO THE MANUFACTURER'S INSTRUCTIONS.

Handling

- Never put the battery pack in a fire, as it could explode and cause injury.
- Do not attempt to open or alter the battery pack.
- Do not place the battery where it might get hotter than 60°C (140°F).
- Do not allow metal objects such as jewelry to short across the battery terminals, as it could heat up and explode.
- Do not allow liquids to come in contact with the battery pack.
- Avoid dropping the pack or other violent shock.
- Do not solder anything to the battery terminals.

Charging

- Charge the battery pack only with the AC adapter included with your computer.

Discharging

- Do not use the battery pack for any purpose other than powering the computer.

Storage

- Store the battery pack in a cool and dry place. Never allow the temperature to exceed 60°C (140°F) during storage.
- Recharge the battery pack after storage, before use.

Modem Precautions

IMPORTANT SAFETY INSTRUCTIONS

When using your telephone equipment, basic safety precautions should always be followed to reduce the risk of fire, electric shock and injury to persons, including the following:

- Do not use this product near water, for example, near a bath tub, wash bowl, kitchen sink or laundry tub, in a wet basement or near a swimming pool.
- Avoid using a telephone (other than a cordless type) during an electrical storm. There may be a remote risk of electric shock from lightning.
- Do not use the telephone to report a gas leak in the vicinity of the leak.
- Never install telephone wiring during a lightning storm.
- Never install telephone jacks in wet locations unless the jack is specifically designed for wet locations.
- Never touch uninsulated telephone wires or terminals unless the telephone line has been disconnected at the network interface.
- Use caution when installing or modifying telephone lines.

About This Manual

Notice

Information in this manual is subject to change without notice and does not represent a commitment on the part of SHARP Corporation.

SHARP Corporation shall not be liable for technical or editorial errors or omissions contained herein; nor for incidental or consequential damages resulting from the furnishing, performance, or use of this material.

SHARP strongly recommends that separate permanent written records be kept of all important data. Data may be lost or altered in virtually any electronic memory product under certain circumstances. Therefore, SHARP assumes no responsibility for data lost or otherwise rendered unusable whether as a result of improper use, repairs, defects, battery replacement, use after the specified battery life has expired, or any other causes.

SHARP assumes no responsibility directly or indirectly, for financial losses or claims from third persons resulting from the use of this product and any of its functions, such as stolen credit card numbers, the loss of or alteration of stored data, etc.

Edition

1st Edition, July 2002.

Copyright

© 2002 SHARP Corporation

This document contains or refers to proprietary information which is protected by copyright. All rights are reserved. Copying or other reproduction of this document is prohibited without the prior written permission of SHARP Corporation.

Trademarks

Intel and Pentium are registered trade mark of Intel Corporation.

IBM is a trademark of International Business Machines Corporation.

SD logo is a trademark.

SmartMedia is a registered trademark of Toshiba Corporation.

Microsoft, MS-DOS, Windows, and the Windows Logo are registered trademarks of Microsoft Corporation.

WinDVD™ is a trademark of InterVideo, Inc.

All other brand and product names are trademarks or registered trademarks of their respective holders.

Recording Important Information

For future reference, please record the following information in the spaces provided below.

Model Number:

Serial Number:

Date of purchase:

Dealer's Name:

Place of purchase:

Password:

The serial number is printed on a sticker located on the bottom of the computer.

Manual Conventions

This manual uses a set of style conventions described below.

Notes and Cautions are italicized with icons:



A note icon informs you of a special technique or information that may help you perform a task or better understand a process.



A caution icon alerts you to something that may cause problems or damage to hardware, software or data.

Key Labels on the Keyboard, when referred to in the instructions, are shown in boldface:

Press **Enter** to continue.

When two or more keys are pressed simultaneously, the key labels are separated by a plus (+) sign:

Restart your computer by pressing **Ctrl+Alt+Delete**.

Sample Entries are shown in lower cases of different typeface.

`c:/windows/system`

Words/Texts on Screen, such as window titles or possible parameters, are italicized:

Double-click this icon to display the *Power Properties* window.

Set the item to *Enabled*.

Screens reproduced in this manual may differ slightly from the screens you see on your computer.

Section Titles in other parts of this manual are italicized:

Refer to *Installing Battery Pack* section of Chapter 1.

Table of Contents

Notice for Users in the UK and Ireland	i
Notice for Users in Europe.....	iii
Safety Precautions.....	vi
About This Manual	ix
Recording Important Information	x
Manual Conventions	xi
Table of Contents.....	xii
Overview of Computer	xiv

Quick Setup

Installing Battery Pack.....	1-1
Connecting AC Power	1-3
Setting Up Windows XP	1-5
Turning Off Your Computer.....	1-6

Basic Operations

Choosing Power Source.....	2-1
Resetting the System.....	2-3
Using the Glide Pad	2-4
Using the Keyboard	2-6
Using the Floppy Disk Drive	2-8
Using the SD Card Slot.....	2-10
Using the Smart Media Card Slot.....	2-12
Using the Optical Drive	2-15
Writing Data to CD-R/RW	2-17
Watching DVD-ROM Video	2-18
Controlling Audio	2-21
Adjusting the Display	2-22
Sharing the Computer	2-24

Battery and Power Management

Battery Pack.....	3-1
Power Management	3-7

Peripherals

Using Peripherals	4-1
Display	4-3
Audio System.....	4-5
USB Device	4-8
PC Card.....	4-9
Printer	4-11
Using IEEE 1394 Devices	4-12

Communication Functions

Built-in Modem.....	5-1
LAN unit.....	5-4

Setup Utility

Running the Setup Utility	6-1
Main Menu.....	6-3
Advanced Menu.....	6-4
Security Menu.....	6-5
Exit Menu	6-7

Appendixes

Memory Module	A-1
Maintenance and Care.....	A-4

Troubleshooting

Index

Overview of Computer

Each number after an arrow indicates the page referring to the part. Actual appearance of your computer may be slightly different depending on the model.

Front

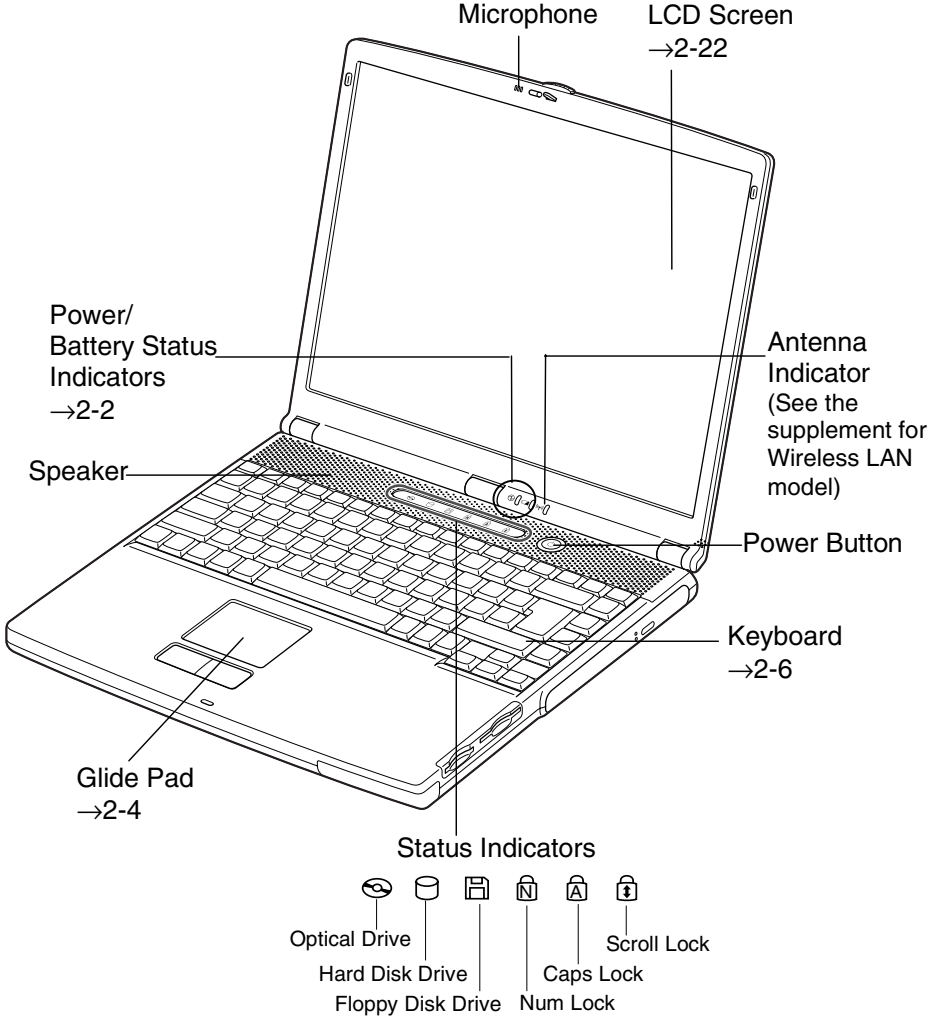

Right

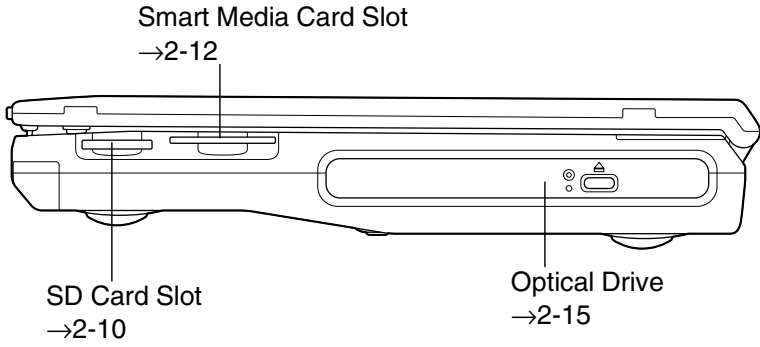

Left

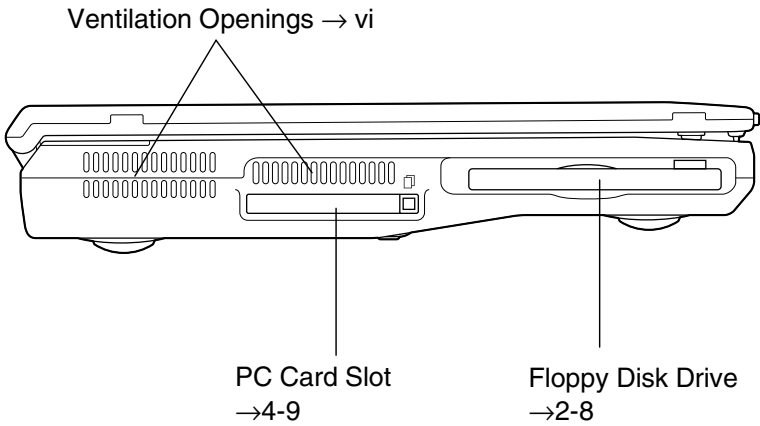

Rear

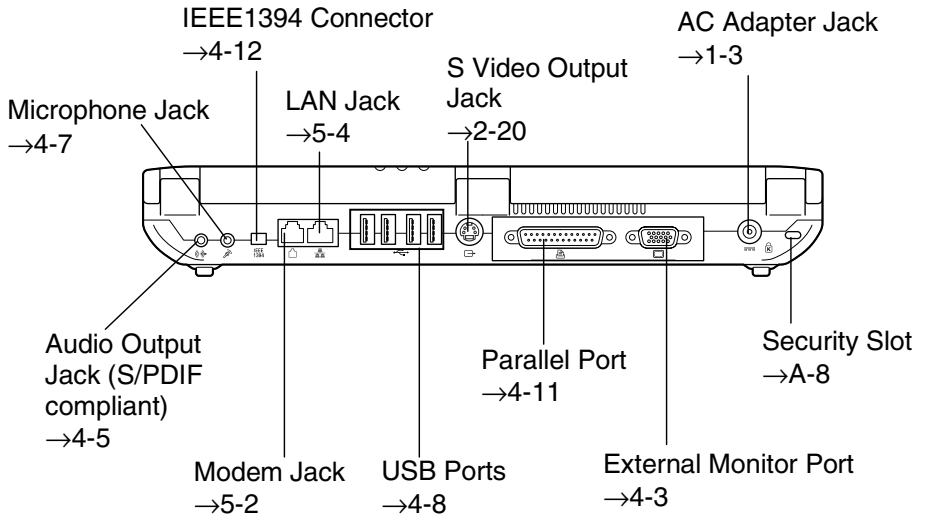

Bottom

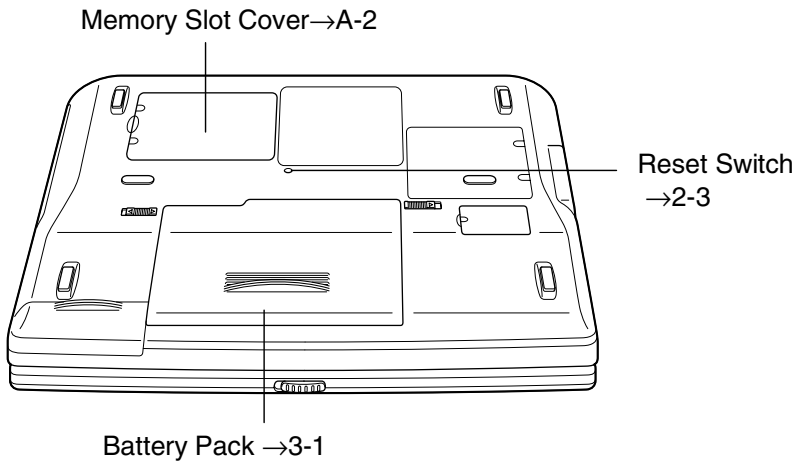

Quick Setup

Your computer is designed and pre-configured for easy setup and use. This chapter describes the steps to set your computer up and running as quickly as possible. Read this chapter first.

Installing Battery Pack

Your computer is powered with either the rechargeable battery pack or AC power. See the next chapter for more information on power sources. Before using the computer for the first time:

1. Place the computer upside down.
2. Slide the battery lock lever to the unlocked position(Ⓐ).

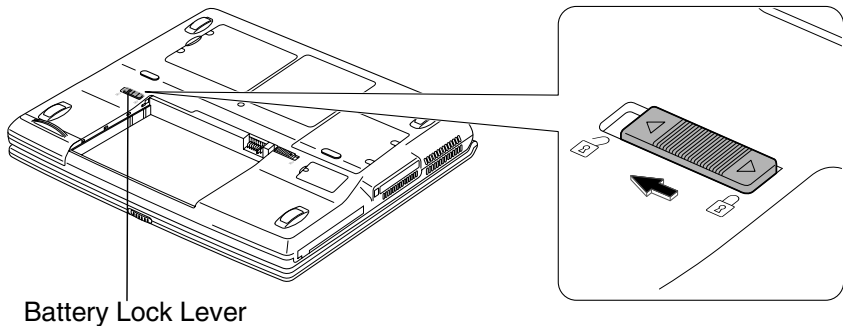

3. Insert the battery pack into the computer.

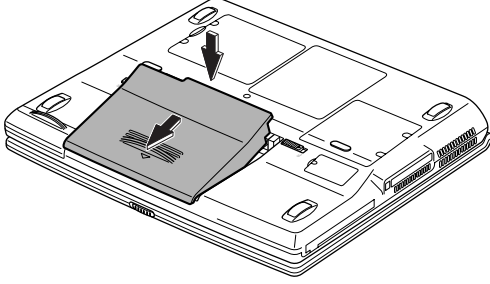

4. Push the battery pack until you hear the clicking sound.

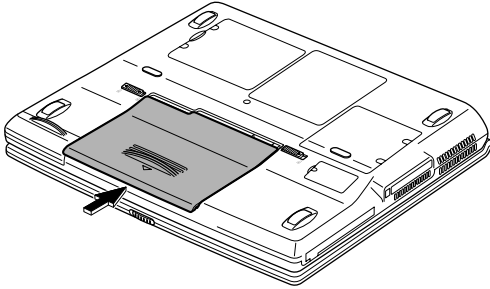

5. Slide the battery lock lever to the locked position (Ⓐ).

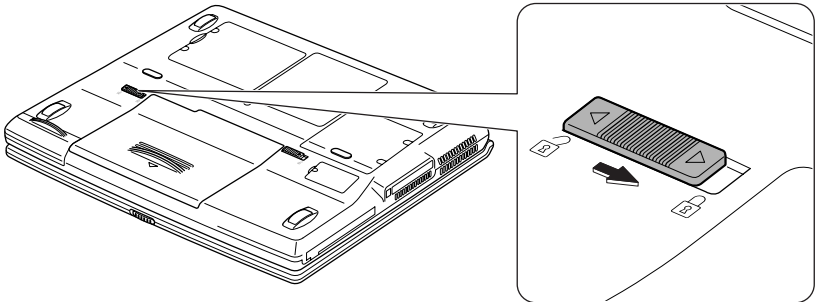

6. Turn over the computer and go to the next section.

Connecting AC Power

1. Plug the AC adapter cable into the AC adapter jack on the rear side of your computer.
2. Plug the AC power cord into the AC adapter.
3. Plug the AC power cord into a wall outlet.

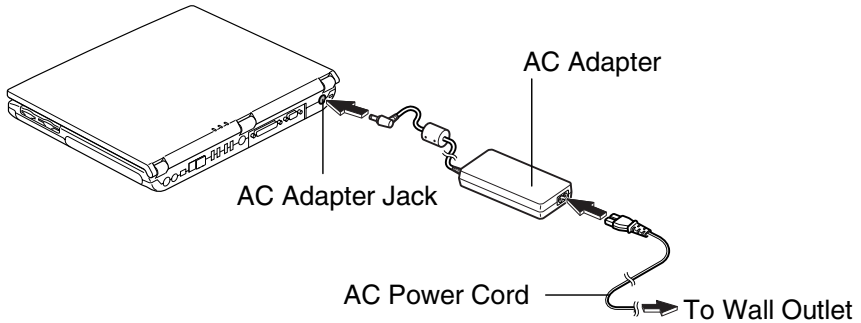

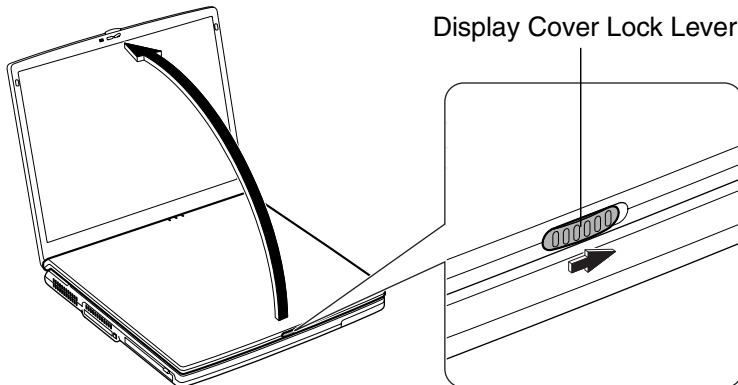

- Always use the AC adapter included with the computer. Using other AC adapters may damage the computer.
- Always hold the AC power cord by its plug when removing it from the wall outlet. Never pull on the cord.
- When using the computer for the first time, be sure to connect it to AC power. When using the battery instead, you may not be able to complete the Windows XP setup if the battery does not have enough power.

4. Slide the display cover lock lever to the right until the display cover releases, and raise the cover.

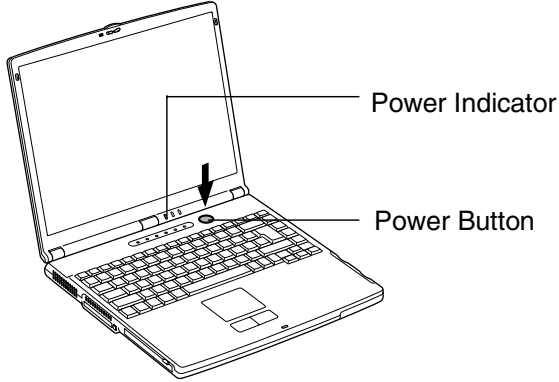

5. Press the power button to turn on your computer.



When you turn on the computer, the power indicator () turns green, the computer goes through a self test to detect any problems, and *Windows XP Setup Wizard* starts. See the next page.

Setting Up Windows XP

The steps in the setup process are as follows:

- Configuring your location, language and keyboard
- Configuring your time zone (for U.S. Users)
- Accepting license agreement
- Naming your computer
- Creating an account
- Completing configuration

To set up Windows XP, follow the instructions on the screen. See also the Windows XP quick start guide. It takes approximately 5-10 minutes to complete the entire setup process.



- *Do not turn off the computer while completing the Windows XP setup.*
- *Be sure to connect the computer to AC power. If the battery is used and it does not have enough power, you may not be able to complete the Windows XP setup.*
- *Do not connect any peripheral devices to your computer until the Windows XP setup completes. Otherwise your computer may malfunction.*



- *If the display turns off, some power management may function. In this case, press any key to resume your computer from the power management.*
- *If you cannot operate the keyboard or the glide pad, press the power button for more than four seconds to turn off the computer. Be sure that the power indicator turns off; then, after more than 10 seconds, press the power button to turn it on again.*

After completing the Windows XP setup, set your date and time. Double-click the time appearing on the right of the taskbar to open *Date and Time Properties* dialog box. Confirm *Time Zone* is correctly selected, and set date and time.

Properties Dialog Box in Windows

In this manual, you will often see the expression “XXX Properties dialog box.” The dialog box is a window containing text boxes, check boxes, buttons, etc., with which you can send commands to Windows or other applications. To open the properties

dialog boxes, click *start - Control Panel*. There are two types of views for the *Control Panel*. One is *Category View*, and the other is *Classic View*. If you select *Category View*, you can choose the category which may be related to what you want to do, then, choose your task by clicking it. If *Classic View* is selected, all the icons appear simultaneously. You can open a property dialog box, or a similar window, for the component or feature represented by that icon, by double-clicking it. Some of the dialog boxes you will use often are:

- Display
- Phone and Modem Options
- Mouse
- Power Options
- System

Turning Off Your Computer

When you've finished using your computer, turn it off using one of the following steps:

- From the *start* menu
 1. Click *start - Turn Off Computer*.
 2. In the *Turn off computer* dialog box, select *Turn Off*.
- With the power button



Before using this step, confirm that *Shut down* is selected in *When I press the power button on my computer* in *Advanced* tab of *Power Options Properties* dialog box (found in the *Control Panel*).

Close the cover to keep the screen and keyboard clean and protected.



If you have not saved the file, a dialog box will appear asking whether you want to save it.



- *Do not turn off or reset the computer when:*
 - *The hard disk, the floppy disk drive or optical drive indicator is lit.*
 - *The  indicator on the taskbar is green or red.*
 - *The  indicator on the taskbar is red.*

Otherwise, the data on your computer may be damaged or even wiped out.
 - *Before turning it back on, wait at least ten seconds after turning off the computer. Turning the power off and on in rapid succession can damage the computer's electrical circuitry.*
-

Basic Operations

This chapter describes the basic operations of your computer.



Choosing Power Source

You can use the computer with one of the following power sources:

- **AC power from a wall outlet**
Use AC power whenever possible; rely on the battery only when AC power is not available.
- **Rechargeable battery**
Your computer is equipped with a battery pack. See Chapter 3 for battery information.

About the Power Indicators

The following indicators show the power status of your computer.

Indicator	Light	Meaning	
Power 	On (green)	Operating (powered by AC power)	
	Blinking (green)	In System Standby (when powered by AC power)	
	Off	Powered off / in System Hibernate/ powered by a battery pack	
Battery Status 	When Connected to AC Power	On (green)	Fully charged
		On (orange)	Being charged
		Blinking (orange)	In abnormal state. Remove the battery pack and install it again. (See Chapter 3)
	When Powered by Battery	Off	Has power
		Blinking (red)	Almost completely discharged (The warning beep sounds)

Battery status indicator is always off when the computer is turned off and not connected to AC power.



- *When the battery is hot, the battery status indicator may turn off and stay off until the battery becomes cool. (See Charging the Battery Pack section of Chapter 3 for more information.)*
- *For more information on System standby/hibernate, see Chapter 3.*

Using the AC Adapter

When connected to a wall outlet, the AC adapter provides power for operation and charges the battery. The AC input voltage can range from 100 to 240 volts so that you can use the computer with the appropriate plug adapter.



The AC power cord included with the computer is appropriate for the voltage used in the area in which you purchased your computer. If you attempt to connect the computer to a wall outlet other than in this area, check the voltage of the outlet and use an AC power cord appropriate for the outlet. Consult local service staff if you are not sure.

Resetting the System

You may need to restart the system if the computer becomes inoperable or after adding a new hardware or software.

Warm Boot (Software Reset)

If the system is locked up because of a software problem, you can reset or reboot the system by pressing the **Ctrl + Alt + Del** keys simultaneously and follow the instructions on the screen.



Resetting may cause data loss. Use the resetting process only if the normal Windows XP Shut Down does not work because of software malfunction. Although resetting will not damage the system, you may lose the data you are processing.

Power Switch

You can turn off the computer with the power button if you encounter hardware or software problems, which lock up the system. In this case, press the power button for more than four seconds.

Reset Switch

If you cannot turn off the computer by pressing the power button, you can use the reset switch on the bottom of your computer. To reset the system, insert a narrow object into the small hole to press the switch.

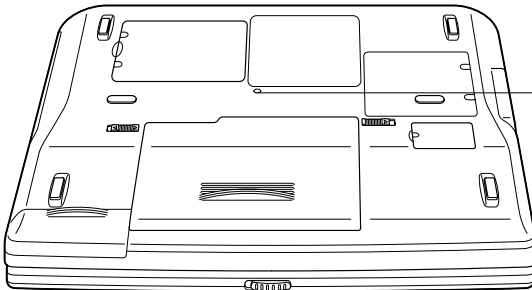

Reset Switch

Using the Glide Pad

Your computer is equipped with an integrated pointing device called glide pad. By moving the pointer with the glide pad, you can select an item from a menu, and perform other tasks in the same way you would with a mouse.

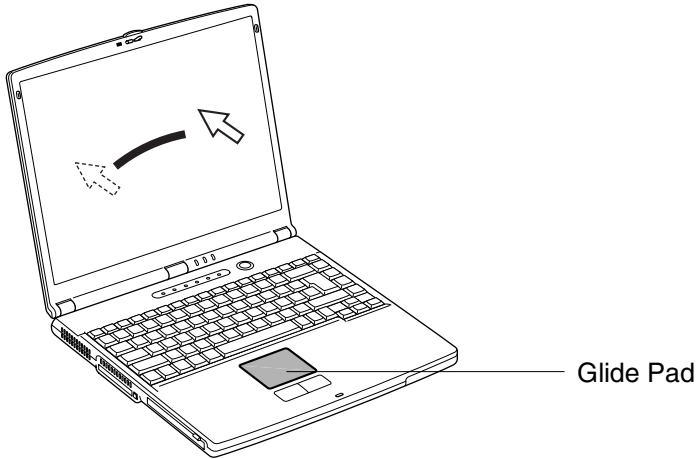

- *Do not hit or scratch the surface of the glide pad with pointed objects (such as a ballpoint pen).*
- *Do not operate the glide pad with a moist finger. This may cause the glide pad to operate incorrectly.*

Using the Glide Pad

Take a moment to become familiar with how the glide pad works.

Place Your Fingertip

Place your left or right hand next to the glide pad, resting your wrist naturally in a relaxed manner. Place your thumb or finger on the glide pad.

Move Your Fingertip

The rectangular pad of the glide pad acts like a miniature duplicate of the display. As you slide your fingertip across the pad, the pointer on the screen moves in the same direction across the screen. The glide pad is very sensitive, so you do not have to exert much pressure on the pad. The glide pad responds to a light touch from your fingertip.

Click, Double-click, and Right-click

To click or double-click, you can use the left button just like that of a mouse. Instead of clicking the left button, you can also just tap gently anywhere on the rectangular pad. For right-clicking, you must use the right button.

Drag and Drop

You can move icons or windows by using “drag and drop” below:

1. Position the pointer over the object.
2. Press the left button; do not release it.
3. Holding down the button, move the pointer. The object moves together with the pointer.
4. Release the button when the object reaches its destination.

Or you can tap the pad twice instead of pressing the left button in step 2.

Scroll

You can scroll through information in a list or in a document by using the glide pad. To view information vertically, place your finger on the most right part of the glide pad and slide your finger up and down. To view horizontally, place your finger on the bottom part of the glide pad and slide your finger to the left or the right. This procedure works only in limited applications.

Changing the Configuration

In the *Mouse Properties* dialog box, you can change the configuration of the glide pad, such as swapping left and right buttons, changing the pointer size, etc. Double-click  icon on the taskbar to open the *Mouse Properties* dialog box.

Using the Keyboard

Your computer, equipped with the Windows Enhanced Keyboard, provides all the functionality of a full-sized desktop keyboard.

Special Keys



Windows Key

Opens the Windows start menu.



Application Key

Opens an application-specific short-cut menu equivalent to right-clicking.

System Function Keys

When pressed together with the **Fn** key, function keys set specific system parameters. This combination is sometimes referred to as “hot keys”.

- | | |
|----------|--|
| Fn + F1 | Turns the wireless LAN connection on and off
(This combination functions for built-in wireless LAN model only and when <i>Wireless LAN</i> in <i>Security</i> menu in the Setup Utility is set to <i>Enabled</i> .) |
| Fn + F3 | Decreases the audio volume |
| Fn + F4 | Increases the audio volume |
| Fn + F5 | Rotates display mode between LCD only, CRT only, and simultaneously display (when connecting a CRT monitor) |
| Fn + F6 | Decreases the LCD screen brightness |
| Fn + F7 | Increases the LCD screen brightness |
| Fn + F8 | Maximizes the LCD screen brightness
Returns to the previous status by pressing them again |
| Fn + F10 | Stops the battery warning beep (This key combination does not work for Windows battery warning beep) |
| Fn + F11 | Turns the LCD screen on and off |

Fn + F12 Forces the computer into System standby/System hibernate/ Shut down
(See *Power Management* of Chapter 3 for more information.)

Using the Floppy Disk Drive

You can use a double-density (2DD) 720KB or high-density (2HD) 1.44MB floppy disk.

Handling Floppy Disks

- Do not open the shutter and touch the disk inside; otherwise, you will not be able to read or write data from/to the disk.
- Do not place floppy disks near magnets or heat source, in direct sunlight or in a dusty place, etc.
- Never subject floppy disks to sudden shocks or extreme vibration. Do not drop or bend them, or place heavy objects on them.
- Do not spill liquid onto floppy disks.

Inserting and Removing a Floppy Disk

Inserting

Hold the floppy disk with the arrow facing up and towards the drive. Slide the disk into the drive until it locks into place. When the disk is correctly inserted, the eject button pops out.

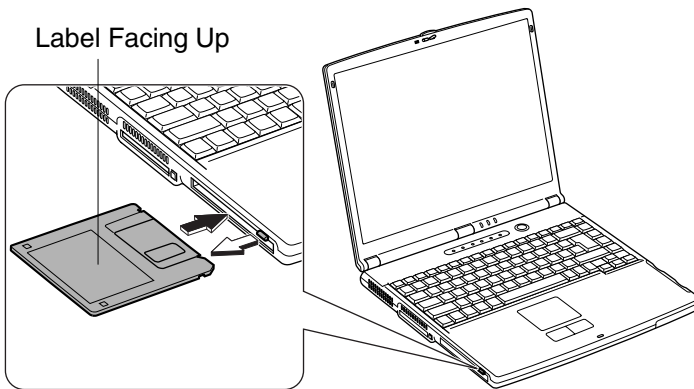

- *Always insert a floppy disk straight into the floppy disk drive.*
 - *When inserting a disk, make sure it is not upside down.*
 - *Do not use excessive force when inserting a floppy disk. If you have difficulty inserting or removing it, seek the assistance of an authorized service technician.*
 - *Do not touch the disk while reading/writing data. It may cause malfunction of the computer and the drive.*
-

Removing



Before removing the floppy disk, make sure the floppy disk drive indicator is not lit.

Press the eject button firmly. The disk pops out slightly. Remove it and store it properly.

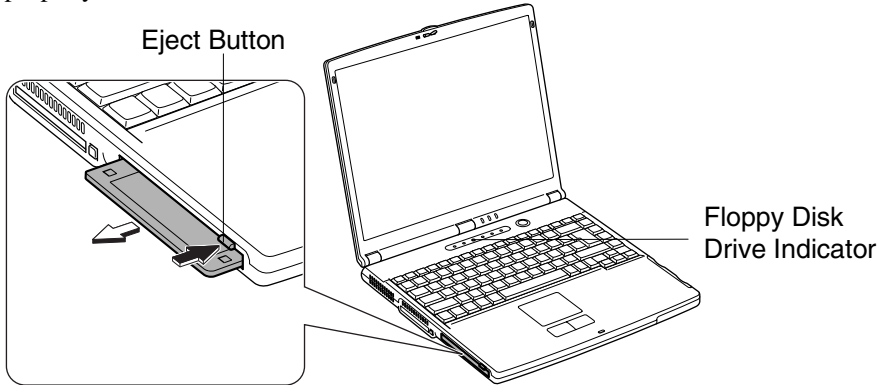

Formatting a Floppy Disk

1. Make sure the floppy disk is not write-protected, and insert it into the floppy disk drive.
2. Click *start - My Computer*.
3. Right-click *3 1/2 Floppy (A:)* icon; then, click *Format....* from the pop-up menu.
4. Select the appropriate formatting options.
5. Click *Start* to start formatting.



- *When you format a floppy disk, all data previously stored on the disk is lost.*
- *You cannot format a double-density (2DD) 720KB floppy disk.*

Using the SD Card Slot

Your computer is equipped with a SD card slot. You can insert/eject a SD memory card without turning off the computer. Before inserting a SD memory card into the slot, refer to its manual.



- You cannot read/write any copy-protected data from/into a SD memory card with built-in the copyright protection technology compliant with the SDMI specification.
- Make sure to log on the computer as a member of the Computer administrators group. Otherwise, you do not have the  indicator on the taskbar and cannot remove the card safely and correctly.

Inserting a SD Memory Card



Make sure to unlock the write protect switch on the SD memory card when you write data into the card. Refer to the manual of the SD memory card for more information about the write protect switch.

Insert a SD memory card into the slot with the SD logo face up and the notched part backward until it locks into place. When the card inserted correctly, the  indicator on the taskbar turns to red; then, green when it is ready for reading or writing.

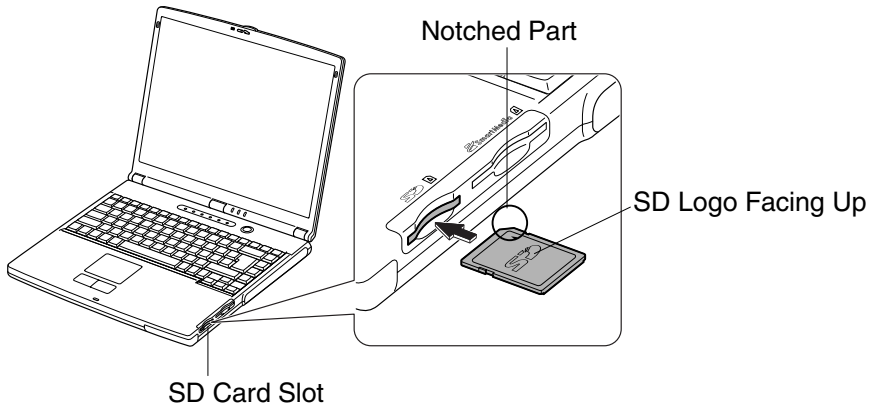

Make sure to insert the card with the SD logo face up and the notched part backward. Otherwise, the card and the computer may be damaged.

If the dialog box asking you *What do you want Windows to do?* appears, select the task you want.

The color of the  indicator means:

Gray : no card in the slot or able to eject the card

Green : able to access the card

Red : reading or writing the data from/into the card

Ejecting a SD Memory Card



- *Do not remove the card nor turn off the computer when the  indicator on the taskbar is green or red. Otherwise, the SD memory card or the data may be damaged.*
- *Be sure to follow the instructions below when ejecting a SD memory card. Otherwise, the system may not work properly.*

1. Click *start – My computer*.
2. Right-click *Removable Disk(E:)*; then, *Eject*. The  indicator on the taskbar turns to gray from green.



Make sure to right-click Removable Disk (E:), not Removable Disk (F:).

3. Push the SD memory card into the computer until you hear the clicking sound. The card pops out slightly.

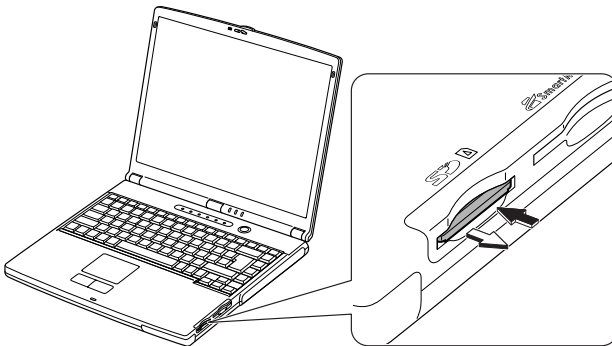

4. Gently pull out the card.

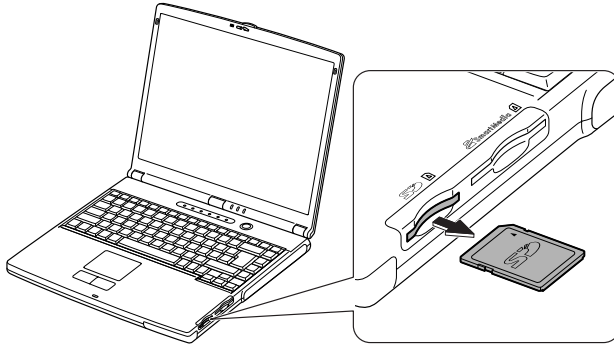

Using the Smart Media Card Slot

Your computer is equipped with a smart media card slot accommodating a 3.3V smart media card. You can insert/eject the card without turning off the computer. Before inserting the card into the slot, refer to its manual.



- Only a 3.3V smart media card is supported by your computer. You cannot use a 5V card with your computer.
- Make sure to log on the computer as a member of the Computer administrators group. Otherwise, you do not have the **SM** indicator on the taskbar and cannot remove the card safely and correctly.

Inserting a Smart Media Card

Insert a smart media card into the slot with the notched part set forward. When the card is inserted correctly, the **SM** indicator on the taskbar turns to red; then, green when it is ready for reading or writing.

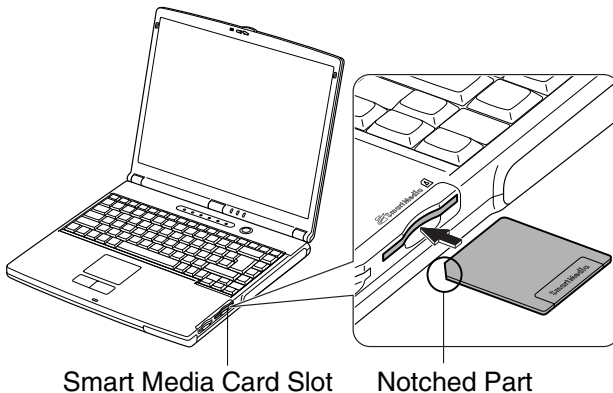



Make sure to insert the card with the notched part forward. Otherwise, the card and the computer may be damaged.

If the dialog box asking you *What do you want Windows to do?* appears, select the task you want.

The color of the **SM** indicator means:

Gray : no card in the slot

Green : able to access the card or able to eject the card

Red : reading or writing the data from/into the card

Ejecting a Smart Media Card



- *Do not remove the card nor turn off the computer when the **SM** indicator on the taskbar is red. Otherwise, the smart media card or the data stored on it may be damaged.*
- *Be sure to follow the instructions below when ejecting a smart media card. Otherwise, the system may not work properly.*

1. Click *start – My computer*.
2. Right-click *Removable Disk(F:)*; then, *Eject*.



Make sure to right-click Removable Disk (F:), not Removable Disk (E:).

3. Push the smart media card into the computer. The card slightly pops out. The **SM** indicator on the taskbar turns to gray from green.

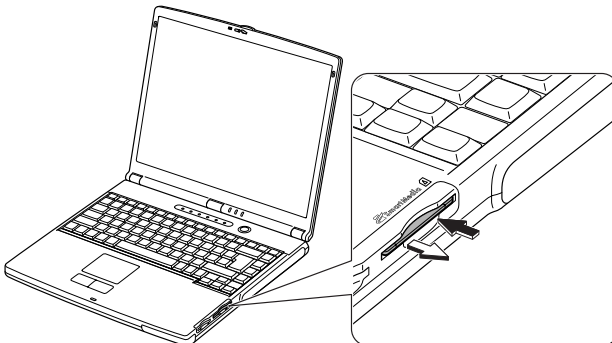

4. Gently pull out the card.

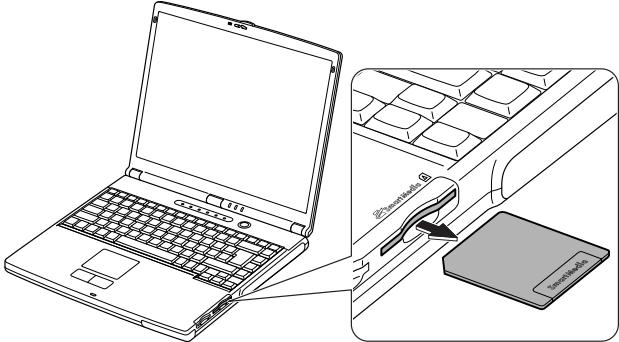

2

Using the Optical Drive

With the optical drive, you can read data from CD and write data into CD-R/RW. Furthermore, you can enjoy a movie etc, with the DVD-ROM disk.



CAUTION FOR LASER

Use of controls or adjustments or performance of procedures other than those specified herein may result in hazardous radiation exposure. Maximum output and wavelength of the laser: 85mW, 795nm(CD-R/RW) 6mW, 668nm(DVD-ROM)



2

Handling Disks

- Do not write on either side of the disk, particularly the non-label side. Data is read from the non-label side. Do not mark this surface.
- Keep your disks away from direct sunlight, heat and excessive moisture.
- Always hold the disks by the edges. Fingerprints, dirt or water on the disks can cause noise or mistracking. If a disk is dirty or does not play properly, clean it with a soft, dry cloth, wiping straight out from the center, along the radius.

Inserting a Disk

1. Make sure the optical drive indicator is not lit on; then, press the eject button. The drive tray opens slightly.

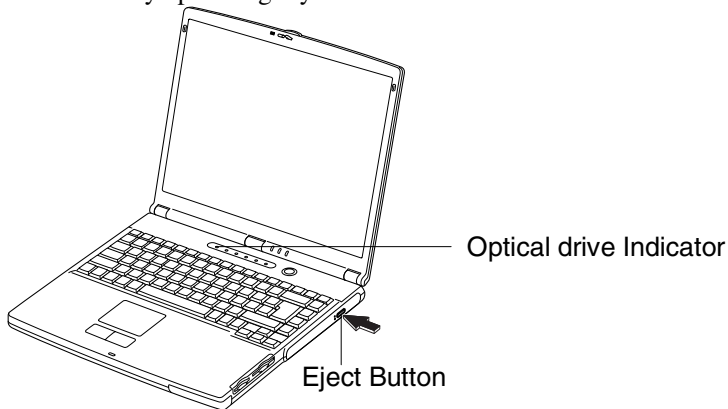

2. Gently pull out the tray.

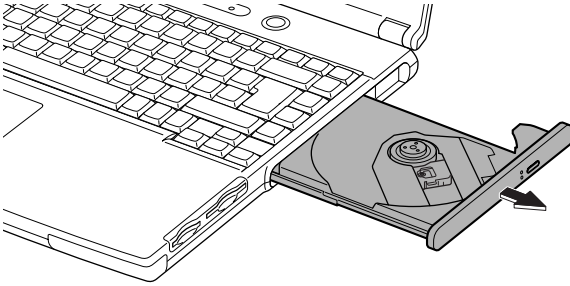

3. Place your disk, label side up, onto the tray and slightly press the center of the disk until it locks into place.

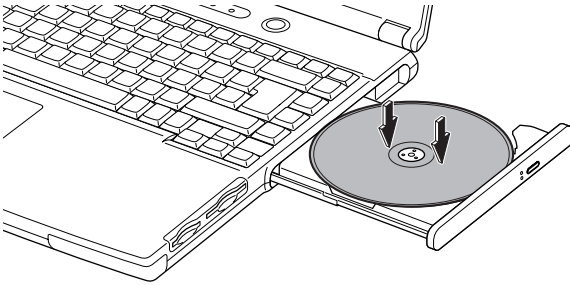

4. Gently push the tray back into the computer.

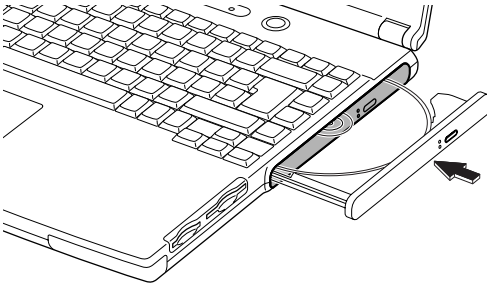

- Do not leave the tray pulled out. Also, avoid touching the lens in the tray. If the lens becomes dirty, the disk may malfunction.
- Do not wipe the lens with materials with rough surface (such as paper towels). Instead, use a cotton swab to gently wipe the lens.

Removing a Disk

1. Make sure the optical drive indicator is not lit and press the eject button. The optical drive tray opens slightly.
2. Gently pull out the tray.
3. Remove the disk from the tray by holding its edge.

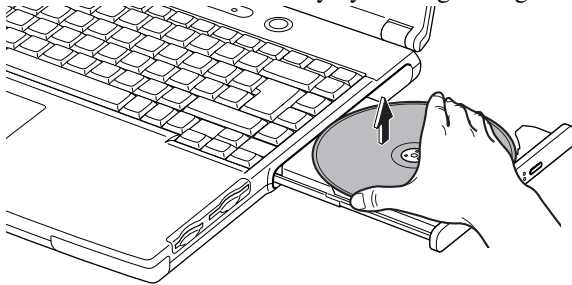

4. Gently push the tray back into the computer.



Make sure the optical drive indicator is not lit or blinking before pressing the eject button.

Writing Data to CD-R/RW

You can use a CD-R or a CD-RW disk to write data on. CD-RW is an erasable disk onto which you can write data and from which you can erase data. CD-R is non-erasable disk onto which you can write data only once. If free space remains, you can add data until the disk is full.

To write data, run the application called *Drag'n Drop CD* installed with your computer. See the online help of *Drag'n Drop CD* for the details.



Before writing to CD-R/RW, follow the instructions below:

- *Connect the AC adapter. If the battery is discharged, writing to the disk will be stopped and the write process will fail.*
- *Disable the power management. See Power Management of Chapter 3.*
- *Close any applications which are unnecessary for writing, or will start automatically when the computer is turned on.*
- *Disable the screen saver.*

Watching DVD-ROM Video

You can enjoy watching DVD-ROM video on your computer using the application called *Win DVD*. See online help of *Win DVD* for more details.



- Before watching DVD-ROM video, follow the instructions below:
 - Connect the AC adapter. If the battery is discharged, the operation will stop.
 - Disable the power management. See Power Management of Chapter 3.
 - Close any applications that are unnecessary.
- This product incorporates copyright protection technology that is protected by method claims of certain U.S. patents and other intellectual property rights owned by Macrovision Corporation and other rights owners. Use of this copyright protection technology must be authorized by Macrovision Corporation, and is intended for home and other limited viewing uses only unless otherwise authorized by Macrovision Corporation. Reverse engineering or disassembly is prohibited.
(Apparatus Claims of U.S. Patent Nos. 4,631,603; 4,577,216; 4,819,098 and 4,907,093 licensed for limited viewing uses only.)



Make sure to remove the DVD-ROM disk from the drive when you finish watching it. If you turn off the computer with the disk left in the drive, the drive may not be recognized when the computer is turned on again.

Changing Region Code

A DVD-ROM disk has a region code which prevents playback of the disk in certain regions. The region code appears on the top of the disk.

When shipped from the factory, your DVD-ROM drive is set to a region code applicable to your area. (may not be available in some areas)

Available region codes are:

Region Code	Area
1	U.S.A, Canada, U.S. Territories
2	Europe, South Africa, Middle East, Japan
3	Southeast Asia, East Asia(including Hong Kong)
4	Australia, New Zealand, Pacific Islands, Central America, Mexico, South America
5	Former Soviet Union, Indian Subcontinent, Africa
6	China

To change the region code:

1. Insert a DVD-ROM disk into the drive.
If the region code of your disk is different from that of your DVD-ROM drive, the message “*Playback of content from this region is not permitted*” appears.
2. Click *OK*. *Confirm Region* dialog box appears.
3. The region code currently selected is checked in the left box. Region code of your disk is checked in the right box. If you want to change the code and play your disk, click *OK*.



On some DVD-ROM disks, plural region codes are selectable in the right box of Confirm Region dialog box. Carefully choose an appropriate code.

Use Parental Control

If you want to set the parental control to prevent your children from watching an inappropriate movie, click  icon of *WinDVD* to open the *Properties...* dialog box, and select *Parental Control* tab. Select the control level and set your password if you want. See online help of *WinDVD* for more details.

Disabling LCD Optimization

Your computer optimizes the screen visibility automatically when you play a DVD video. When the screen is not appropriate for you, disable the LCD optimization function. Click  icon of *WinDVD* to open the *Properties...* dialog box, and select *Display* tab; then, uncheck *LCD Optimization*.

Displaying Video on Your TV Set

You can connect a television set with S-Video input to your computer and enjoy DVD video on a big display.



- *Before connecting the television set, disconnect the external monitor.*
- *Connect the computer and the television set directly. Otherwise, the screen may be distorted.*

1. Turn off the computer and the television set.

2. Connect the television set to your computer.

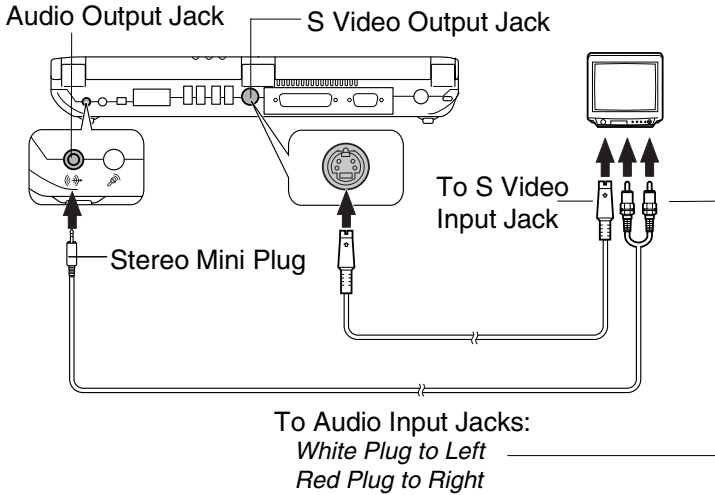

3. Turn on the computer and the television set.
4. Right-click somewhere on the Windows desktop and click *Properties* from the pop-up menu. *Display Properties* dialog box opens.
5. Click *Settings* tab - *Advanced* button - *Utility Manager* tab; then, select *Driver Mode Settings* icon.
6. Set *Primary of Driver mode* to *TV* and click *OK* twice.
7. If you can see the screen image on the television set, click *Yes*.
8. Click *OK* and close *Display Properties* dialog box.



- Before disconnecting the television set, be sure to turn off the computer and the television set.
- After disconnecting the television set, set back the display property following the steps 4 to 6 and set the appropriate resolution.

Enjoying Dolby Digital Audio

Your computer is Dolby Digital compliant. If you connect Dolby Digital compliant audio equipment or headphones, you will have an audio output similar to a big theater. For connection, refer to *Audio System* of Chapter 4.



WinDVD is equipped with Dolby Headphone™ properties. You can enjoy Dolby sound just by connecting normal headphones. To set this function, click  icon and select *Dolby Headphone* tab. The *Dolby Headphone* properties page is available only while you are playing a DVD-ROM disk. Refer to the online help of WinDVD for more details.

Controlling Audio

You can control the output volume of your computer with the following steps.

With the keyboard

Press **Fn** and **F3** keys simultaneously to decrease the output volume.

Press **Fn** and **F4** keys simultaneously to increase the output volume.

This operation also adjusts the Windows volume control below. For example, if you press **Fn + F3** keys, the volume level in Windows will decrease, too.

In Windows

1. Click *start - Control Panel*.
2. Click *Sounds, Speech, and Audio Devices*; then, *Sounds and Audio Devices*. If Classic view is selected, double-click *Sounds and Audio Devices* icon.
3. In *Sounds and Audio Devices Properties* dialog box, slide the lever to control the output volume.
4. Click *OK* and close the dialog box; then the *Control Panel* window.



Check the box of Place volume icon in the taskbar on the step 3 of the above. Next time you find the speaker icon on the taskbar, and it is easy to control the volume.

If you want to control the output volume of each source individually:

1. Click *start - Control Panel*.
2. Click *Sounds, Speech, and Audio Devices*; then, *Sounds and Audio Devices*. If Classic view is selected, double-click *Sounds and Audio Devices* icon.
3. In *Sounds and Audio Devices Properties* dialog box, click *Advanced...* button of *Device volume* section.
4. Slide the lever of the source that you want to control.
5. Close the dialog box, then; click *OK* and close the *Control Panel* window.

If you control:

- | | | |
|------------------|---|--|
| Wave | → | Controlling the volume of CD/DVD or WAVE file |
| SW Synth | → | Controlling the volume of MIDI file |
| CD Player | → | Controlling the volume of CD/DVD if the application selects analog playback. |

Adjusting the Display

You can adjust the brightness, resolution, and number of colors of the internal LCD display.

Changing Brightness of Display

Press **Fn** and **F6** keys simultaneously to decrease the brightness of the display.
Press **Fn** and **F7** keys simultaneously to increase the brightness of the display.
Press **Fn** and **F8** keys simultaneously to maximize the brightness of the display.
To return the previous brightness, press them again.

Changing Resolution and Number of Colors

When shipped, your computer is set to the default resolution and color. The default resolution is 1024 x 768 at 64k colors. To change the resolution and the number of colors, follow the instructions below:

1. Right-click anywhere on the Windows desktop, except icons or folders.
2. Select *Properties* from the pop-up menu.
3. In the *Display Properties* dialog box, select *Settings* tab.
4. Select the number of the colors in *Color quality*, and select the resolution in *Screen resolution*. Refer to the table below for possible resolution and colors.
5. Click *OK*. If the *Monitor Setting* dialog box appears, click *Yes*.

Resolutions and Colors you can choose

Resolution	Number of Colors
800 x 600	64K 16M ^(*1)
1024 x 768	64K 16M ^(*1)
1280 x 1024 ^(*2)	64K 16M ^(*1)
1600 x 1200 ^(*2)	64K 16M ^(*1)
1920 x 1440 ^(*2)	64K 16M ^(*1)
2048 x 1536 ^(*2)	64K 16M ^(*1)

(*1) On the internal LCD screen, the number of colors in this mode is made using a Dithering algorithm.

(*2) Can be chosen for an external monitor only when it is capable of the listed resolution modes. Cannot be set when displaying only on the LCD monitor and on both of LCD and an external monitor simultaneously.



- *You cannot switch to a display resolution and number of colors that are not available.*
- *In the Color quality, Medium (16 bit) means 65,536 (64K) colors, and Highest(32 bit) means about 16,770,000 (16M) colors.*
- *If you select Highest, drawing speed may be delayed.*

Changing Wallpaper and Setting Screen Saver

You can enjoy various desktop patterns or screen savers.

Changing Wallpaper

1. Follow the steps 1 and 2 on the previous page.
2. In the *Display Properties* dialog box, select *Desktop*.
3. Select an appropriate wallpaper in *Background*.
4. Click *OK*.

Setting Screen Saver

1. Follow the steps 1 and 2 on the previous page.
2. In the *Display Properties* dialog box, select *Screen Saver*.
3. Select an appropriate screen saver in *Screen saver* and set time when screen saver starts.
4. Click *OK*.

Sharing the Computer

If you are sharing the computer with your colleagues or family members, set a user account for each person. Every user can choose his/her favorite desktop setting, web site lists, or make his/her own *My Documents* folder etc., and save them to his/her user account. When you turn on the computer, select your user account.

Set a New User Account

1. Click *start - Control Panel*.
2. Click *User Accounts*. If Classic view is selected, double-click *User Accounts* icon.
3. Click *Create a new account*.
4. Type a name for the new account and click *Next*.
5. Select the account type; then, click *Create Account*. If you have selected a *Limited* account, then that user account has limits for using the computer. See *Help and Support Center* for more details.
6. Close the *User Accounts* dialog box; then, the *Control Panel* window.

If more than one user accounts are set to the computer, you must select which user account you will log in when you turn on the computer.

Log off the Computer

“Log off” is useful because you do not have to turn off the computer when you finish your task and pass the computer to another person. There are two ways to log off the computer; *Switch User* and *Log Off*.

If you select *Switch User*, you can pass the computer to another person without closing your current applications. For example, if you are viewing a Web site, and your colleague needs to open a program on the computer, use *Switch User*. You can then view the same Web site by just switching users after your colleague finishes with the computer.

If you select *Log Off*, the system will close all your session and you need to save your files before logging off the computer.

1. Click *start - Log Off*.
2. Select *Switch User* or *Log Off*. If you select *Log Off*, the dialog box, which asks you to save your data may appear.
3. Select another account to start Windows XP again.



If you cannot see Switch User in Log Off Windows dialog box, click Change the way users log on or off in User Accounts dialog box, and check Use Fast User Switching and click Apply Options.

Set Password to User Account

You can set a password to each user account to avoid unauthorized use of your computer. Once you set the password, you need to enter it when you log on to your account. If you lose the password, you cannot start the computer with that user account, so unnecessary password setting can cause trouble in starting the system.

Setting Password

1. Click *start - Control Panel*.
2. Click *User Accounts*. If Classic view is selected, double-click *User Accounts* icon.
3. Select the account you want to set a password to. You will only have this option if you log onto the computer as a member of the Computer administrators group. If you log on the computer with a limited user account, skip this step. (You cannot set a password to another user account.)
4. Select *Create a password*.



- *If the password has been already set, Create a password will not appear.*
- *Only the members of the Computer administrators group can set a password to another user account.*

5. Type a new password.
6. Type the new password again to confirm it.
7. If necessary, type a password hint word to remember the password you set.
8. Click *Create Password*.
9. Close the *User Accounts* dialog box; then, the *Control Panel* window.

Changing Password

1. Follow the steps 1-2 on *Setting Password* section.
2. Select the account you want to change, if you log on to the computer as a member of the Computer administrators group. If you log on the computer with a limited account, skip this step. (You cannot change the password for another user account.)
3. Select *Change my password* or *Change the password*.



- If the password has not been set yet, *Change my password* or *Change the password* will not appear.
- Only the members of the Computer administrators group can change the password of another user account.

4. Type a new password.
5. Type the new password again to confirm it.
6. If necessary, type a password hint word to remember the password you set.
7. Click *Change Password*.
8. Close the *User Accounts* dialog box; then, the *Control Panel* window.

Deleting Password

1. Follow the steps 1-2 on *Setting Password*.
2. Select the account you want to delete, if you log on to the computer as a member of the Computer administrators group. If you log on the computer with a limited account, skip this step. (You cannot delete the password of another user account.)
3. Select *Remove my password* or *Remove the password*.



- If the password has not been set yet, *Remove my password* or *Remove the password* will not appear.
- Only a member of the Computer administrators group can delete the password of another user account.

4. Type your password and click *Remove Password*. If you log on the computer as a member of the Computer administrators group and want to delete the password of another user account, just click *Remove Password*.
5. Close the *User Accounts* dialog box; then, the *Control Panel* window.

Battery and Power Management

This chapter explains how to manage the computer's power effectively and use the battery pack.



In this section, you often see the expression “Power Options Properties dialog box”. To open the dialog box:

1. *Click start - Control Panel.*
2. *Click Performance and Maintenance - Power Options in Category view or double-click Power Options icon in Classic view.*

Battery Pack

When not connected to an external power source, your computer operates with the rechargeable battery pack. The duration of the battery life may be longer if the computer's Power Management is active. See the next section for power management.

To keep the battery life long:

- Condition (see “*Conditioning the Battery Pack*” in this chapter) the battery pack if the actual remaining power in your battery is less than what Windows Power Meter indicates.
- Turn off your computer when you are not using it.



- *The duration of the battery depends on the computer usage. Using applications, which heavily use the optical drive or external peripherals, will result in shorter battery life.*
- *When using the computer for several hours with battery packs, enable power management and set System hibernate. Refer to the Power Management section in this chapter.*

- *When the battery has not been charged, your computer may not operate properly. Connect the AC power to charge the battery.*

Charging the Battery Pack

1. Connect the AC adapter to the computer. While the battery is being charged, the battery status indicator turns orange.
2. When the battery is fully charged, the battery status indicator turns green. Charging time may vary according to the status of the computer.



- *Battery status indicator may turn off even while the battery pack is being charged. This is either because the battery pack is hot or else the system power consumption is very high due to using the optical drive or CPU-intensive application, and the charging stops temporarily. When the battery becomes cool, the charging will start and the battery status indicator will turn on again.*
- *The battery pack may not be installed correctly if the battery status indicator blinks orange. In this case, turn off the computer, remove the AC adapter and the battery pack; then, install the battery pack and connect the AC adapter again. If the battery status indicator still blinks orange, ask your local dealer for assistance.*
- *When the battery pack is hot (for example, after a long usage), it may take longer to be fully charged.*

Checking the Battery Level

You can check the battery level by pointing to the battery or AC plug icon on the taskbar, or double-clicking the icon to open the *Power Meter* dialog box. If the battery is fully charged, remaining capacity level will not appear even if you point the icon.

If you cannot see the battery or AC plug icon, follow the instructions below:

1. In the *Power Options Properties* dialog box, select *Advanced* tab.
2. Check *Always show icon on the taskbar* and click *OK*.
3. Close the *Control Panel* window.



- *The remaining operating time depends on the power you are consuming. If you are using the audio system, hard disk drive, any of the PC, SD and smart media card slots, any peripherals, floppy disk or optical disk, your computer may consume more battery life.*
- *If the actual remaining power in your battery is less than what Windows Power Meter indicates, you should condition the battery pack as per the procedure on Conditioning the Battery Pack section.*

Low Battery Indication

When the battery power becomes significantly low (under 10%), the battery status indicator (🔋) blinks red, the warning beep sounds. Save your data and turn off the computer, or connect the computer to AC power immediately. Otherwise, the computer will be shut down and the data may be lost. To stop the warning beep sound, press **Fn + F10**.

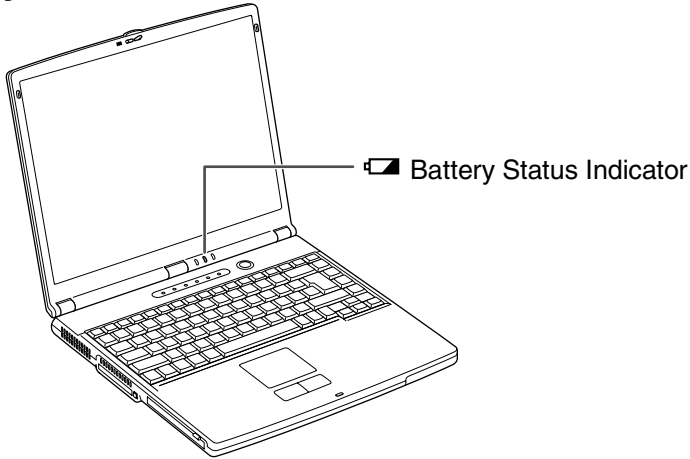

In Windows XP, the alarm will tell you when the battery drops to the specified level by sounding an alarm or displaying a message, and let your computer go on *System standby/hibernate* or shut down automatically.

To set Windows battery alarm:

1. In the *Power Options Properties* dialog box, select *Alarms* tab.
2. Set the battery level at which the alarms are activated. We recommend you set *Critical battery alarm* to 5 % or more and *Low battery alarm* to more than that of *Critical battery alarm*.
3. Set the *Alarm Action...* to the appropriate settings.
4. Click *OK* twice.
5. Close the *Control Panel* window.

Conditioning the Battery Pack

You need to condition the battery pack when the actual remaining power in your battery is less than what Windows Power Meter indicates, or you buy a new battery pack.

1. Make sure the computer is turned off. Connect the computer to AC power and wait until the battery is fully charged. The battery status indicator turns orange first; then, turns to green when the battery pack is fully charged.
2. Turn on the computer.
3. When the message <F2> to enter System Configuration Utility appears, press **F2** to open the Setup Utility.
4. Disconnect the AC adapter, and leave the computer on until the battery is completely discharged and the system shuts down automatically.
5. Connect the computer to AC power and let the battery fully charged again.
6. Turn on the computer and follow the steps 3 to 5 again.
7. Restart the computer. The conditioning process is complete.



Do not connect the computer to a wall outlet while discharging the battery. The conditioning will be cancelled.

Changing the Battery Pack

The capacity of a battery pack gradually decreases when used repeatedly (the deterioration rate depends on the operating environment). If the battery life becomes extremely short even after the conditioning, you should buy a new battery pack. Ask your local dealer for a new battery pack.

When you replace the battery pack with a new one:

1. Turn off the computer and disconnect the AC adapter from the computer.
2. Close the display cover and turn over the computer on a flat place.

- Slide the battery lock lever to the unlocked position (a).

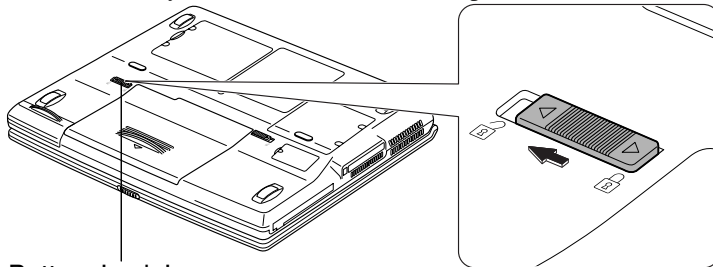

Battery Lock Lever

- Slide the battery release lever to the unlocked position (a) and hold it; then, pull out the battery pack slightly.

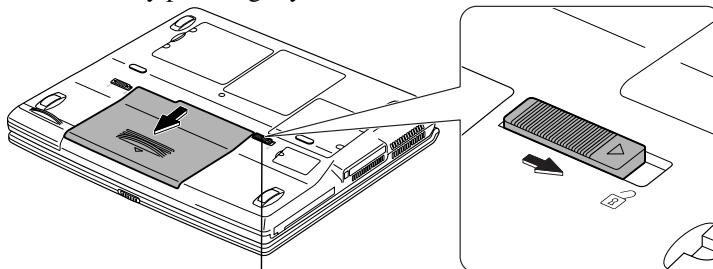

Battery Release Lever

- Lift up the battery pack and remove it from the computer.

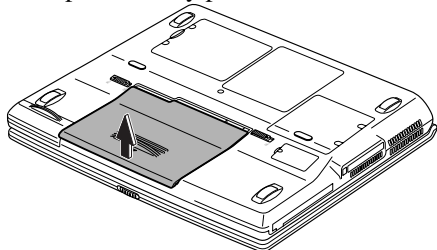

- Insert a new battery pack into the computer.

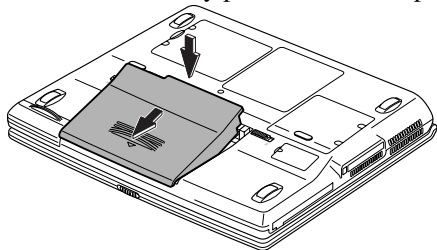

7. Push the battery pack until you hear the clicking sound.

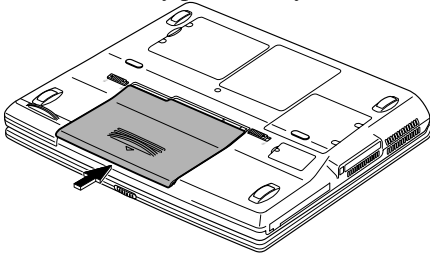

8. Set the battery lock lever to the locked position (Ⓐ).

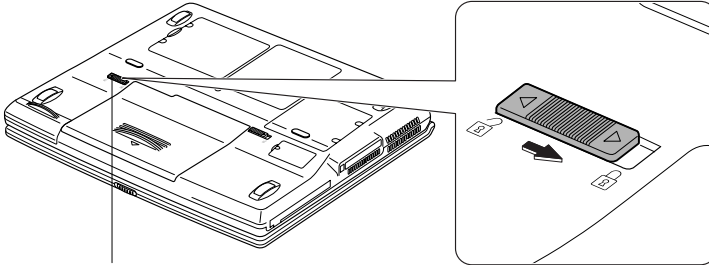

Battery Lock Lever

9. Turn over the computer and it's ready to use.

Power Management

Power management saves electricity and extends battery life by controlling power supply to built-in devices. You can set the following power management properties in Windows XP.

- Stopping power supply to the hard disk
- Stopping power supply to the display
- Using System standby/hibernate

To open *Power Options Properties* dialog box, click *start – Control Panel*, and click *Performance and Maintenance*; then, *Power Options*. If Classic view is selected, double-click *Power Options* icon.



Note that the power management may not seem to function when you are using an application program that accesses the hard disk periodically.

Stopping Power Supply to the Hard Disk

1. In the *Power Options Properties* dialog box, select *Power Schemes* tab.
2. Set *Turn off hard disks* to an appropriate value, and click *OK*.
3. Close the *Control Panel* window.

Stopping Power Supply to the Display



This procedure is also effective for a connected external monitor complying with power management.

1. In the *Power Options Properties* dialog box, select *Power Schemes* tab.
2. Set *Turn off monitor* to an appropriate value, and click *OK*.
3. Close the *Control Panel* window.

Using System Standby/Hibernate

System standby/hibernate is a very useful power management tool. For example, after your computer has entered *System standby* mode, you can restart your computer more quickly when compared to a restart, after a normal shutdown operation. When your computer resumes from *System standby/hibernate*, the system restores the exact last state of the computer. In Windows XP, you can define *System standby* or *System hibernate* the system enters under what conditions.

- *System standby* stores the current condition of the computer in RAM and stops power supply to all but a few essential components. Your system enters and resumes from *System standby* per the conditions mentioned later. In *System standby*, the Power indicator or the battery power indicator blinks green. To resume from *System standby*, operate the computer again.
- *System hibernate* saves the current condition of the computer in an area of the hard disk and turns off the computer. Your system enters and resumes from *System hibernate* per the conditions mentioned later. In *System hibernate*, the power indicator or the battery power indicator turns off. To resume from *System hibernate*, press the power button.



When entering/resuming from System standby/hibernate, follow the instructions below:

- *Finish communications, printing, and playing music or video before entering System standby/hibernate.*
 - *Do not operate the computer or peripheral devices, or connect/disconnect peripheral devices, while entering/resuming from System standby/hibernate.*
 - *While operating with a battery, the computer may not resume from System standby/hibernate if the battery capacity is not enough. In this case, connect the AC adapter to your computer.*
 - *Save your data before your computer enters System standby. If the power supply to the computer is stopped, the RAM contents will be lost.*
 - *Select your user account if Windows requires when the computer has resumed from System standby/hibernate.*
-

Supporting System Hibernate



If your battery becomes completely discharged during System standby, you will lose unsaved data and will need to reboot your computer. Therefore, if you are planning to leave your computer powered by battery for long periods of time, we recommend System hibernate.

Confirm that *System hibernate* is supported with the following steps.

1. In the *Power Options Properties* dialog box, select *Hibernate* tab.
2. Confirm *Enable hibernation* is checked.
3. Click *OK*.
4. Close the *Control Panel* window.

Set Timer to Enter System Standby/Hibernate Automatically

Your computer will enter System standby/hibernate automatically when the specified time has passed without any operation. To set the time:

1. In the *Power Options Properties* dialog box, select *Power Schemes* tab.
2. Set the time after which the computer will enter System standby/hibernate in *System standby* or *System hibernates*.
3. Click *OK*.
4. Close the *Control Panel* window.

Entering System Standby/Hibernate

Your computer enters *System standby/hibernate* in one of the following cases:

- You select *Stand By* or *Hibernate*(which will appear if you press **Shift** key) in the *Turn off computer* dialog box. To open the dialog box, click *start – Turn Off Computer*.
- The specified time in *System standby* or *System hibernates* in *Power Schemes* tab of *Power Options Properties* dialog box has passed without any operation. (See the previous section.)
- The screen cover is closed.

The above functions if you perform the following:

1. In the *Power Options Properties* dialog box, select *Advanced* tab.
2. Select *Hibernate* or *Stand by* in *When I close the lid of my portable computer*.
3. Click *OK*.

4. Close the *Control Panel* window.

- You press the power button.

The above functions if you perform the following:

1. In the *Power Options Properties* dialog box, select *Advanced* tab.
2. Select *Hibernate* or *Stand by* in *When I press the power button on my computer*.
3. Click *OK*.
4. Close the *Control Panel* window.

- You press **Fn + F12**.

The above functions if you perform the following:

1. In the *Power Options Properties* dialog box, select *Advanced* tab.
2. Select *Hibernate* or *Stand by* in *When I press the sleep button on my computer*.
3. Click *OK*.
4. Close the *Control Panel* window.



*If Ask me what to do is selected in the step 2 of You press the power button or You press **Fn + F12**, the Turn off computer dialog box will appear when you press the power button or **Fn + F12** key combination. You can select System standby or System hibernate at that timing.*

- The battery level is low.

The above functions if you set the alarm in Windows XP. See *Low Battery Indication* in this chapter.

Disabling Power Management

1. In the *Power Options Properties* dialog box, select *Power Schemes* tab.
2. Set *Turn off monitor*, *Turn off hard disks*, *System standby*, and *System hibernates* to *Never*, and click *OK*.
3. Close the *Control Panel* window.

Peripherals

This chapter describes how to use peripheral devices with your computer. You can connect a printer, external monitor, or other devices to your computer. To ensure proper use, be sure to read the instructions for each peripheral device before connecting it to your computer.

Using Peripherals

You can use the peripheral devices shown on the next page. For the details, refer to the section explaining each device, or contact your dealer.



- *Be sure to turn off the computer and the peripheral device before connecting them (except when connecting USB devices, IEEE1394 devices or inserting a PC card).*
- *Confirm the peripheral device you will connect is Windows XP compatible.*
- *Some devices have to be turned on after the computer is turned on.*
- *Some devices require that you install drivers before use.*

Peripheral Connection Overview

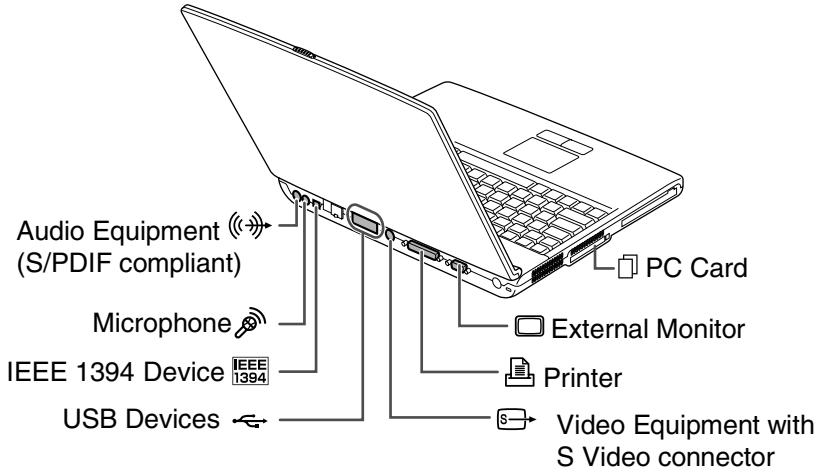

Display

You can use an external monitor with your computer. To display images on both displays simultaneously, use the 1024x768 resolution.



- *Some monitors, which are not compatible with your computer, may not display correctly.*
- *In this section, you often see the expression “Display Properties dialog box.” To open the dialog box, right-click somewhere on the Windows desktop and select Properties from the pop-up menu.*

Connecting External Monitor

1. Turn off the computer and the external monitor.
2. Connect the computer and the external monitor. If the cable has screws, be sure to tighten them.

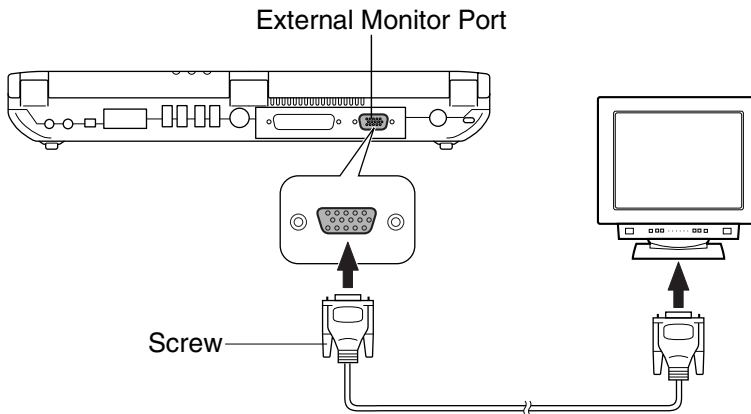

3. Turn on the external monitor; then, the computer.



Be sure to turn off the computer and the external monitor before disconnecting them.

Displaying the Screen on an External Monitor

To display the screen on an external monitor, you may need to install the driver for your external monitor. Before using the external monitor, refer to the manual included with your external monitor.

Switching the Display

1. In the *Display Properties* dialog box, select *Settings* tab; then, click *Advanced* button.
2. Select *Utility Manager* tab; then, *Driver Mode Settings* icon.
3. Select the appropriate mode in *Driver mode* section.



- *When displaying on the LCD monitor:*
Set Driver mode to Single and Primary to LCD.
- *When displaying on the external monitor:*
Set Driver mode to Single and Primary to VGA.
- *When displaying on both monitors simultaneously:*
Set Driver mode to Mirror.

4. Click *OK* twice; then, *Yes*.
5. Click *OK* twice.



- *You can also switch the display with **Fn+F5**.*
- *While playing video or animation, you may not be able to switch the display.*
- *When displaying on both of the LCD monitor and the external monitor simultaneously, the external monitor should be capable for displaying in 1024 × 768 resolution or more. Otherwise, you may not display images on the external monitor properly.*
- *To change the resolution and colors, refer to Adjusting the Display of Chapter 2.*

Audio System

You can output sound to speakers, audio equipment or a headphone.

Connecting Speakers

You can connect stereo speakers with an amplifier to the audio output jack on the rear side of the computer.

Audio Output Jack

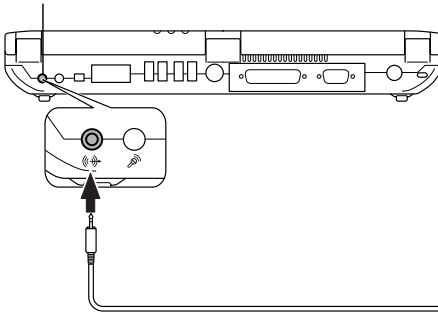

Speakers with an Amplifier

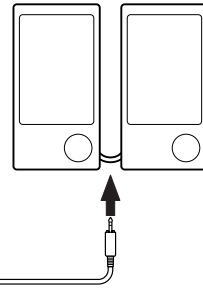

Connecting Digital Audio Equipment

The audio output jack of the computer is compliant with S/PDIF (Sony/Philips Digital Interface). You can connect a S/PDIF compliant audio equipment to the computer and output/record the sound.

Audio Output Jack

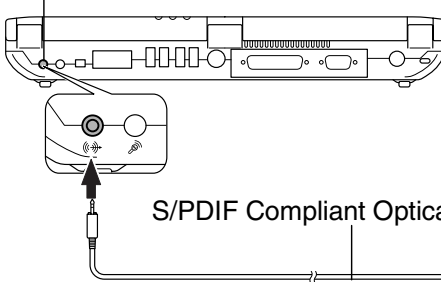

S/PDIF Compliant Audio Equipment

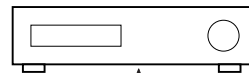

S/PDIF Compliant Optical Audio Cable



When recording sound with an audio equipment:

- *Use AC adapter for the computer and the digital audio equipment.*
- *Exit other application programs.*
- *Disable Windows power management.*

- Do not enter System standby/hibernate.
- Do not operate the computer.
- Use the digital audio equipment compliant with sampling rate of 48kHz.
- Sound may not be recorded correctly if you use the synchronized recording system of the digital audio equipment.

Connecting Analog Audio Equipment

Audio Output Jack

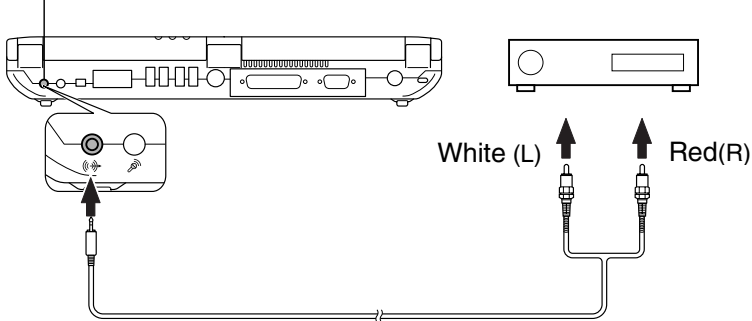

4



You can adjust the output volume in Windows XP by double-clicking the speaker icon on the taskbar or use **Fn + F3** or **F4** keys combination.

Connecting Headphone

Use headphones with an impedance of more than 8Ω (32Ω is recommended).

Audio Output Jack

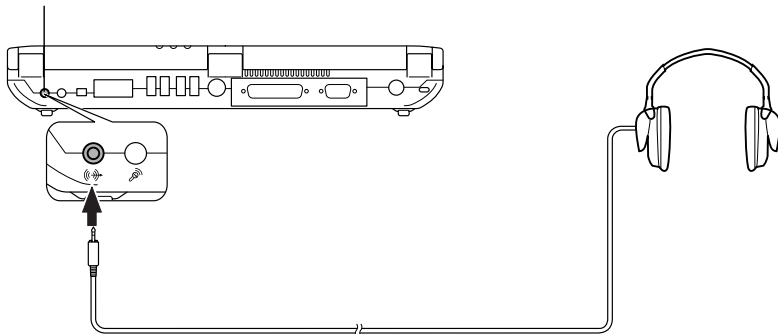

Connecting a Microphone

You can input sound using an external microphone connected to the microphone jack. Use an electret condenser microphone with an impedance of $2.2\text{k}\Omega$ and an allowable voltage of 2.5V .

Microphone Jack

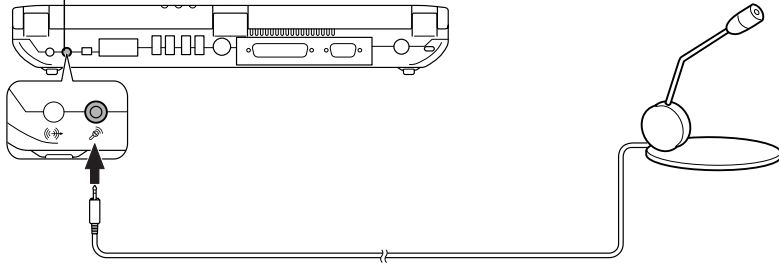

To record sound:

1. Click *start*; then, point *All Programs – Accessories – Entertainment*.
2. Click *Sound Recorder*.
3. See *Help for Sound Recorder* for more details.

USB Device



Your computer has an interface called Universal Serial Bus (USB). With a USB connection, you can connect/disconnect peripherals without turning off the computer. Generally, when you connect a device to the computer, the necessary driver will be installed automatically. See also the manuals of peripheral devices supporting USB.

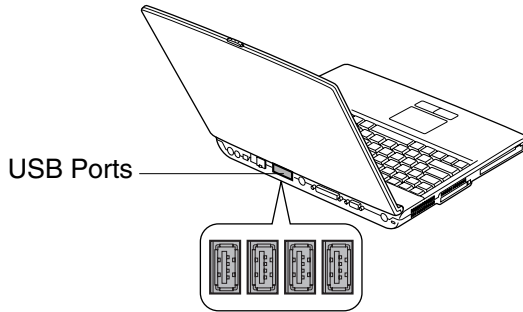

When a new device is correctly connected to the computer, the appropriate driver is automatically installed. If the driver is not installed correctly, you will see the message in the lower right of the screen. In this case, install the driver by following the instructions on the screen.



To remove USB devices, you may need to perform the following before you remove them:

1. Click *Safely Remove Hardware* icon () on the taskbar. If you cannot find the icon, click  to show all kinds of icons. If the icon does not appear, go to Step 3.
2. Click *Safely remove xxxxxxx*. (*xxxxxxx is the name of the USB device*); then, *Safe To Remove Hardware* dialog appears.
3. Remove the USB cable from the computer.

PC Card

Your computer is equipped with a PC card (PCMCIA) slot, which can accommodate a Type II or a CardBus compliant card. You can insert/eject a PC card without turning off the computer. Before inserting a PC card into your computer, refer to its manual.

Inserting a PC Card



When a new card is correctly inserted, the appropriate driver is automatically installed. If the driver is not installed correctly, you will see the message in the lower right of the screen. In this case, install the PC card driver by following the instructions on the screen.

1. Confirm the PC card eject button is inside the computer cabinet. If the button is not inside the computer cabinet, push it back into the computer.

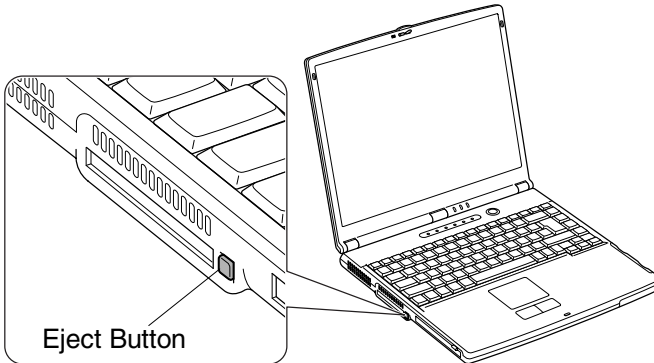

2. Insert a PC card into the slot with the label face up until it locks into place.

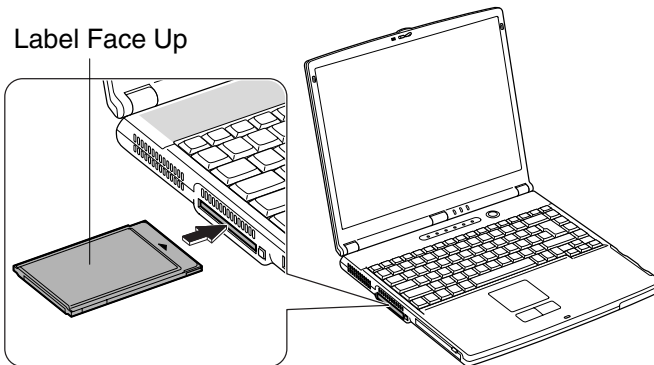



If the dialog box asking you *What do you want Windows to do?* appears, select the task you want.

Ejecting PC Card



- *Some PC cards may become hot after long use.*
 - *Be sure to follow the instructions below when ejecting a PC card. Otherwise, the system may not work properly.*
-

1. Click the *Safely Remove Hardware* icon () on the taskbar. If you cannot find the icon, click  to show all kinds of icons.
2. Click *Safely remove xxxxx*. (xxxxx is the name of your PC card); then, *Safe To Remove Hardware* dialog appears.
3. Push the PC card eject button so that it pops out from the side of the computer.

Eject Button

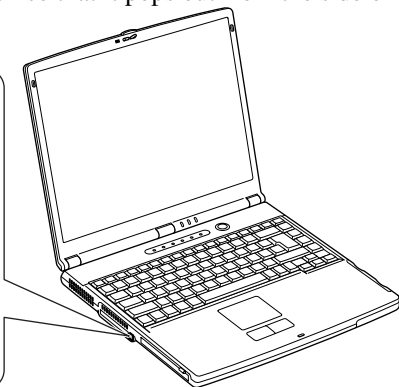
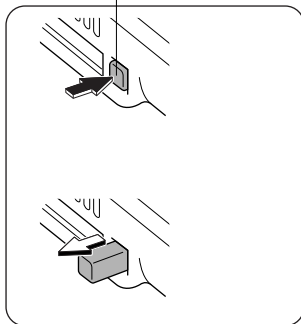

4. Push the eject button and remove the PC card.

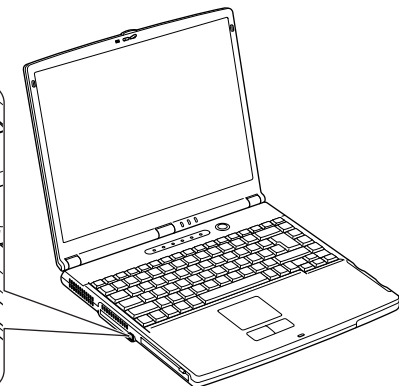
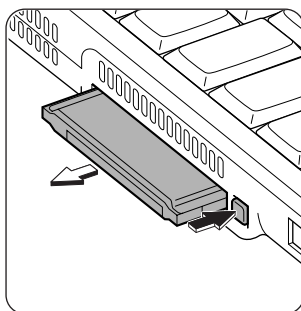

5. Push the PC card eject button all the way inside the cabinet for safekeeping.

Printer

You can connect a printer to the parallel port or the USB port.



Before using a printer, read the printer manual and install the printer driver.

Connecting to Parallel Port

1. Turn off the computer and the printer.
2. Connect the computer and the printer with the printer cable. If the connector has screws, tighten them.

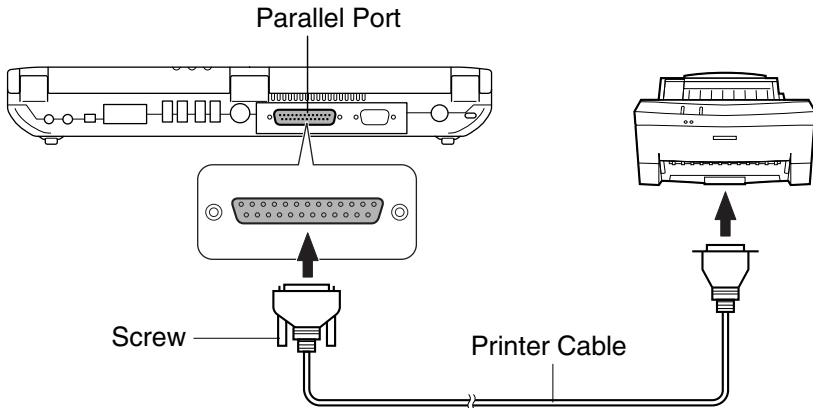

3. Turn on the printer; then, computer.

Connecting to USB Port



Be sure to read the printer manual before connecting the USB printer to the computer. Some printer may not use New Hardware Find wizard to install the printer driver.

You can connect the USB printer to the computer without turning off the computer.

Using IEEE1394 Devices

You can connect the IEEE 1394 devices to the IEEE1394 port on the rear side of the computer. The IEEE 1394 is a digital interface for handling digital video, digital audio and other data in two directions between devices, and for controlling other equipments.

When two or more IEEE 1394 compatible devices are connected to the computer in a daisy chain, operations and data transactions are possible with not only the equipment that is directly connected, but also with other devices via the directly connected device.



- *Confirm the IEEE 1394 device you will connect is Windows XP compatible.*
- *Use AC power for the computer and the IEEE 1394 device especially when reading/writing the data.*
- *Some IEEE 1394 devices require that you install drivers before use.*

4

Connecting IEEE 1394 Device



- *Attach the provided core to the DV(IEEE1394) cable to insure compliance with requirements of EMC regulations for computing equipment.*
- *You need not turn off the computer before connecting the device.*
- *Be sure to read the manuals of the IEEE 1394 device before connecting it to the computer.*

1. Attach the provided core to one end of your DV (IEEE1394) cable. Insert the cable into the core and put the cable around the core; then, close the core until it clicks.

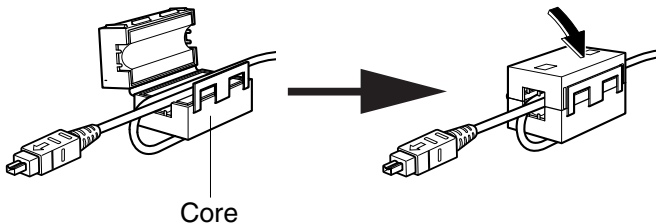

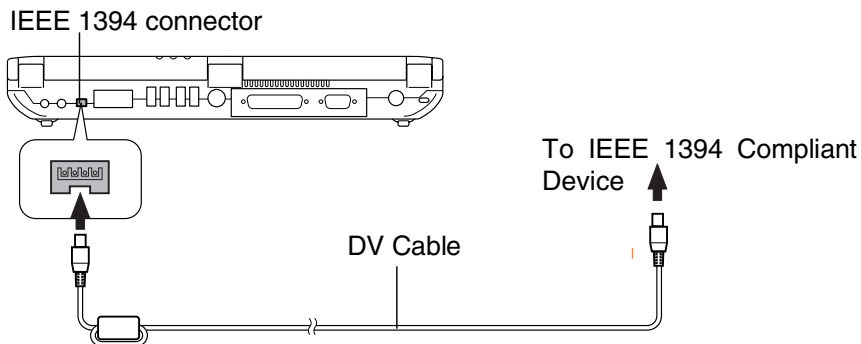

2. Connect the core end of the DV cable into the IEEE 1394 connector of the computer and the other end into the DV connector of the IEEE 1394 device.



3. Install the driver according to the instructions on the screen. Generally when you connect the device to the computer, the necessary driver will be installed automatically.
4. Start the appropriate application for handling your data.

Disconnecting IEEE 1394 Device

1. Click the *Safely Remove Hardware* icon () on the taskbar. If you cannot find the icon, click  to show all kinds of icons. If the icon does not appear, go to Step 3.
2. If the name of your device appears, click *Safely remove xxxxx* (xxxxx is the name of your IEEE 1394 device.); then, *Safe To Remove Hardware* dialog appears.
3. Remove the DV cable from the computer.

Communication Functions

This chapter explains how to use the built-in modem and the LAN unit.

Built-in Modem

You can use the built-in modem for data transfer and fax communication.



- *To reduce the risk of fire, use only No. 26 AWG or larger telecommunication line cord.*
 - *The built-in modem on your computer is designed only for regular analog telephone lines. The modem may be damaged when connected to a digital ISDN terminal or a digital PBX.*
 - *Use TA (terminal adapter) to connect the built-in modem to a digital telephone line.*
 - *If an unusual device is attached to the line you are connecting to, the modem may not function properly. Remove the device or contact the dealer of the device.*
 - *Before connecting to a PBX, consult the PBX maintenance staff or its service company. If the electric characteristics of your PBX are different from those of a regular analog line, the modem will not function properly. If you connect the modem to a digital PBX, both the modem and the PBX may be damaged.*
-

Connecting the Modem to a Telephone Line

1. Turn off your computer.
2. Connect the core end of the included modem cable to the modem jack (with  mark) on the rear side of the computer. Connect the other end of the modem cable to the telephone line.

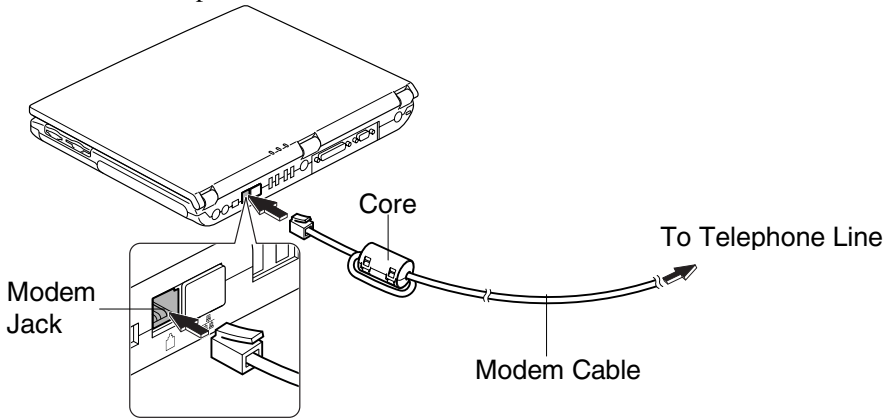

Be sure not to insert into the LAN jack (with  mark). It may damage both the modem cable and the LAN jack.

3. Turn on the computer.



Connect the modem to the telephone line directly. Do not use a distributor or alloter.

Configuring the Modem

You may have already configured your modem during Windows XP Setup process. Otherwise, make the necessary adjustments as shown below.

Modem Configuration

When you use the modem first time, you must type your location's information.

1. Click *start - Control Panel*.
2. Click *Printers and Other Hardware*; then, *Phone and Modem Options*. If Classic view is selected, double-click *Phone and Modem Options* icon.

3. In *Location Information* dialog box, select your country, type your area code, etc., and select your dial type; then, click *OK* twice.
4. Close the *Control Panel* window.

Next time you click or double-click *Phone and Modem Options*, *Phone and Modem Options* dialog box appears. You can find the information you set in the steps on the previous page by double-clicking the location name of *Dialing Rules* tab.

You can change the settings or make a new location by clicking *Edit ...* or *New ...*

Internet Connection

Windows XP has a special Internet Connection Wizard to help you to connect to the Internet with ease. Click *start – Control Panel*. Click *Network and Internet Connections*; then, *Network Connections*. If Classic view is selected, double-click *Network Connections* icon. In *Network Connections* dialog box, click *Create a new connection of Network Tasks*. When the *New Connection Wizard* dialog box appears, follow the instructions on the screen. If you plan on connecting to the Internet by using the modem to dial an Internet Service Provider (ISP), have your account information and dial-up number ready before you begin the wizard. Once you set your connection, you can see or edit the connection status by double-clicking the icon appearing on *Dial-up* of *Network Connections* dialog box.

Power Management

To use the communication software, you may have to disable power management. See *Disabling Power Management* of Chapter 3.



- See also the manual or online help of the software you are using.
- Within the communications software you are using, set the COM port of the built-in modem to COM3.
- Do not enter System standby/hibernate while using communication software.
- The communication speed may vary depending on the traffic, local telecommunications infrastructure, and ISP (Internet Service Provider) infrastructure.
- Before commencing with fax communication, it is recommended that you exit other application programs.

LAN unit

You can connect to a LAN (Local Area Network) with the 100 Base-TX/10 Base-T LAN unit on your computer. To activate the LAN unit, perform the following steps.



Use a category 3 or a category 5 LAN cable when connecting to 10 BASE-T LAN, and the category 5 when connecting to 100 BASE-TX LAN.

Connect your computer to LAN

1. Turn off the computer.
2. Attach the provided core to one end of your LAN cable. Insert the cable into the core and put the core around your LAN cable; then, close the core until it clicks.

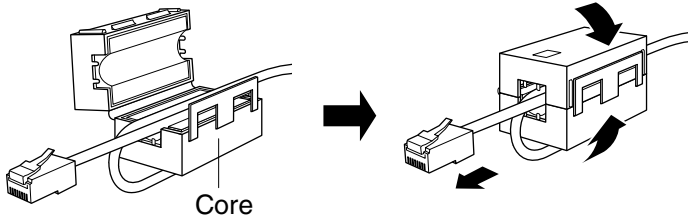

3. Remove the cover of the LAN jack on the rear side of your computer.

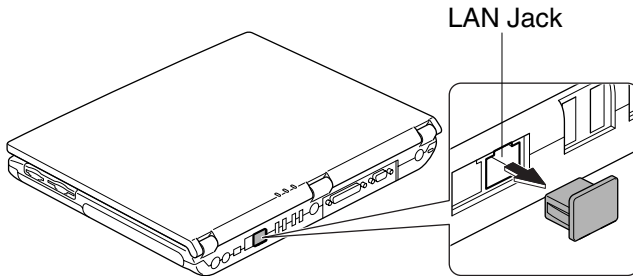

4. Connect the core end of the LAN cable into the LAN jack (with  mark) and connect the other end of the LAN cable into the network hub.

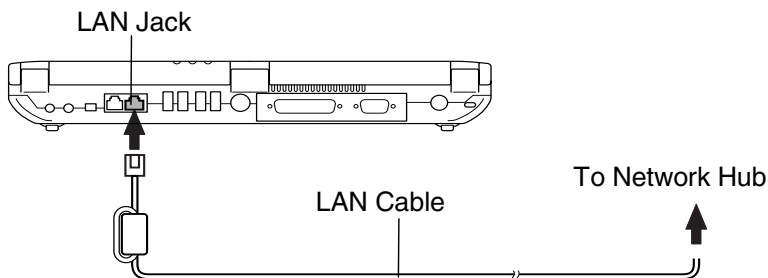

Do not insert into the LAN cable to the modem jack (with  mark). It will damage the LAN cable and the modem jack.

5. Turn on the computer.
6. Click *start - Control Panel*.
7. Click *Network and Internet Connections*; then, *Network Connections*. If Classic view is selected, double-click *Network Connections* icon. Set the network setting according to the instruction of your network administrator.



Attach the provided core to your LAN cable to insure compliance with requirements of EMC regulations for computing equipment.

If you cannot access the network,

1. Click *start - Control Panel*.
2. Click *Performance and Maintenance*; then, *System*. If Classic view is selected, double-click *System* icon.
3. Click *Hardware* tab; then, *Device Manager* button.
4. Double-click *Network adapters*, then, *SiS 900-Based PCI Fast Ethernet Adapter*.
5. Click *Advanced* tab, and select *Media Type* in *Property* and select an appropriate value in *Value*.
6. Click *OK* and close the *Device Manager* window.
7. Click *OK*.
8. Close the *Control Panel* window.

Setup Utility

This chapter describes how to run the Setup Utility to change settings on your computer.

Running the Setup Utility

With the Setup Utility, you can customize the system configuration information, such as time and date, port assignments, or passwords. The information you have specified is saved in a special area called CMOS RAM, which the system reads every time you turn on the computer. Your computer is shipped from the factory with the appropriate setting of the Setup Utility. Leave it as default in normal use.

Contents of the Setup Utility

The Setup Utility consists of four menu pages, as follows:

- **Main:** Configures basic setting
- **Advanced:** Configures device interface (I/O ports, etc.)
- **Security:** Sets Passwords
- **Exit:** Exits the Setup Utility or returns to the default values

Entering and Exiting the Setup Utility

1. Turn on the computer.
2. When <F2> to enter *System Configuration Utility* appears, press **F2**. The Setup Utility opens.
3. Set the settings to the appropriate ones. Refer to the next section.
4. Select *Exit* menu; then press **Enter**.
5. Select one of the exit methods, and press **Enter**.
6. Confirm the message and press **Enter** again. The system restarts.

Changing the setting of the Setup Utility

To change the settings:

1. Use → or ← key to select the menu; then press **Enter**.
2. Use ↑ or ↓ key to select the item.

If the item has √ or —:

Press **Enter** to enable or disable the item. √ mark means the item is enabled. — Mark means disabled.

If the item has no mark (except *Date and Time* of *Main* menu and *Set Password* of *Security* menu):

1. Press **Enter** to open the sub menu.
2. Use Tab key to highlight the value; then use ↑ or ↓ key to select the value. The value with • is being selected.
3. Use Tab key to highlight *OK*; then press **Enter**.

To set *Date and Time*:

1. Press **Enter**.
2. Use arrow keys to highlight the value; then use minus key or space bar to change the value.
3. Use arrow keys to highlight *OK*; then press **Enter**.

To set *Set Password*: see *Security Menu* in this chapter.

3. Close the Setup Utility according to the steps above.



When the Setup Utility is opened, power management does not work. Do not close the display cover.

Main Menu

Date and Time defines the system date and time. Use arrow keys to select the value, and minus key or space bar to change value.

Hard Disk Type shows the type of the hard disk of your computer. Press **Enter** to show the details. Leave it as default in normal use.

Boot Sequence specifies where the system boots from. Press **Enter** to open the sub menu. The system boots from the drive selected in *1st Boot Device*. If the system cannot find the drive, it will boot from the drive selected in *2nd Boot Device*; then, the drive selected in *3rd Boot Device*.

Internal Numlock defines whether **Fn +NumLk** key combination always works or not. If you will use the keypad area of the external keyboard only, set it to *Disabled*.

Hot Key Beep defines whether the beep sounds when **Fn +F5-F8, F10-F12** keys simultaneously pressed.

Advanced Menu

LPT Port sets the printer port, selecting the base I/O address and IRQ. *Disabled* means that you cannot use the port. *Mode* can be selected from *Bi-Directional*, *ECP* (Extended Capabilities Port mode), *EPP* (Enhanced Parallel Port mode) or *Output Only*.

Internal Pointing Device enables or disables the built-in glide pad.

Shared Video Memory defines the size for the video memory which will be shared with the extended memory.

TV SYSTEM switches TV type between PAL and NTSC.

Battery Low Warning Beep enables or disables the beep sound when the battery remaining capacity becomes extremely low (this item does not work for Windows battery alarm).

LAN Boot defines whether the system boots from the PXE server when the integrated LAN is activated.

Wake On LAN defines whether the system resumes from System Standby when the LAN unit of the computer becomes active.

Wake On Ring defines whether the system resumes from System Standby when the built-in modem receives a call.

Security Menu

Set Password defines the password (up to eight characters). See the next section about the password setting.



If you lose your password, you will be unable to access the computer or change the configuration. Make sure to select a password you will never forget, or write it down and protect it in a secure place. Otherwise, you will have to contact your dealer for assistance.

Hard Disk Virus Protect defines whether the boot sector of the hard disk is write-protected. When formatting the hard disk or reinstalling software, set it to disabled.

Password

Setting a password will protect your computer against unauthorized access. When a password is set, the system requires the password when entering the Setup Utility. And if *Password On Boot* is enabled, the system will require a password when the computer is turned on. Refer to the next section.



*If you enter a wrong password three times, the message “The password is incorrect. System will be shut down” appears. Press **Enter** to shut down the computer, and after 10 seconds, press the power button to turn it on again.*

Setting the Password

1. In the *Security* menu of the Setup Utility, select *Set Password* and press **Enter**.
2. Type your password (up to eight characters), and press **Enter**.
3. Type the same password again, and press **Enter**.
4. If you want the password required when booting, confirm *Password On Boot* is marked with **√**.
5. Use Tab key to highlight *OK* and press **Enter**.
6. Select *Exit* menu and confirm *Exit Saving Changes* is highlighted; then press **Enter**.
7. Confirm *OK* is highlighted and press **Enter**. The system restarts.

Changing the Password

1. In the *Security* menu of the Setup Utility, select *Set Password* and press **Enter**.
2. Type your current password, and press **Enter**.
3. Type your new password, and press **Enter**.
4. Type your new password again, and press **Enter**.
5. If you want the password required when booting, confirm *Password On Boot* is marked with **√**.
6. Use Tab key to highlight *OK* and press **Enter**.
7. Select *Exit* menu and confirm *Exit Saving Changes* is highlighted; then press **Enter**.
8. Confirm *OK* is highlighted and press **Enter**. The system restarts.

Deleting the Password

1. In the *Security* menu of the Setup Utility, select *Set Password* and press **Enter**.
2. Type your current password, and press **Enter**.
3. Without typing any characters, press **Enter**.
4. Press **Enter** twice.
5. Select *Exit* menu and confirm *Exit Saving Changes* is highlighted; then press **Enter**.
6. Confirm *OK* is highlighted and press **Enter**. The system restarts.

Exit Menu

Exit Saving Changes saves the settings you have changed and exits the Setup Utility.

Exit Discarding Changes exits the Setup Utility without saving the settings you have changed.

Load Setup Defaults returns the values of all items to the default. To exit, select one of the above items.

Discard Changes returns the values of all items to the values you last saved. To exit, select one of the above two items.

Save Changes saves the settings you have changed. To exit, select one of the above two items.

Appendixes

The appendixes contain additional information on the use and care of your computer.

Memory Module

You can expand the memory size up to 512MB by installing a memory module(s) of 128MB or/and 256MB. For an available memory module, ask your local dealer. A 512MB model is not memory expandable. See the specification on the provided Supplement for the memory size of your computer.

Installing a Memory Module



- *Do not handle the memory module where static electricity is easily generated such as on the carpet.*
 - *Before installing the memory module, carefully discharge static electricity from your body by touching an unpainted metal area.*
 - *Avoid touching the integrated circuits on a memory module. Handle all components by the edges.*
 - *Keep the memory module in the anti-static wrapping until you are ready to install it.*
-

1. Turn off the computer, and disconnect the AC adapter and remove the battery pack and peripheral devices. See Chapter 3 for removing the battery.
-



- *Make sure to turn off your computer and remove the AC adapter. Otherwise you may get an electrical shock.*
 - *After a long usage of the computer, the temperature inside the computer may be hot. Wait until it becomes cool.*
-

2. Loosen two screws and remove the memory slot cover.

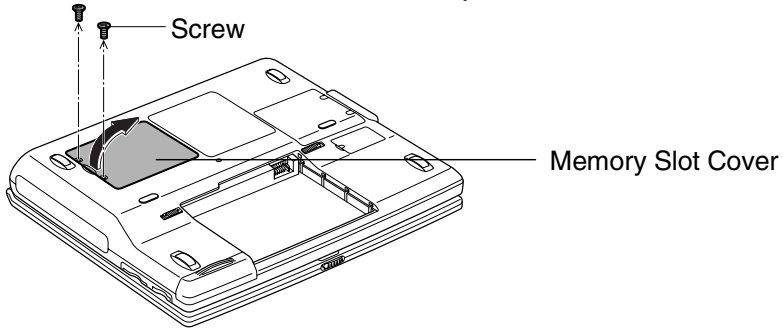

3. Turn over the sheet and align the memory module as shown below, matching the notched part of the module with the projected part of the memory socket of the computer.

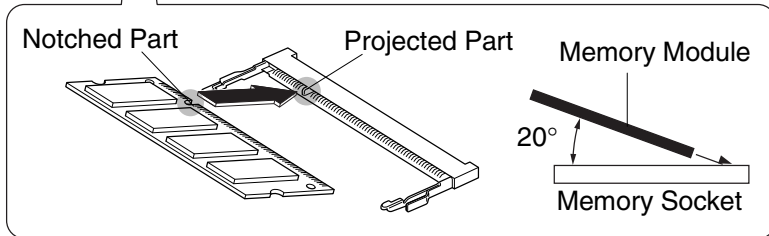
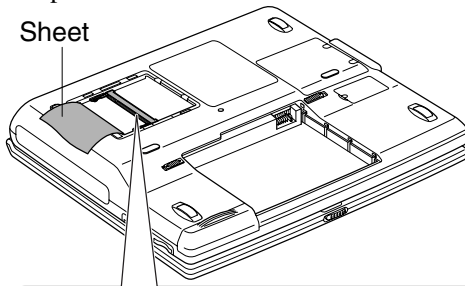

4. Press the memory module softly to place it into the memory socket, matching the notched parts of the module with the projected parts of the memory socket, until you hear the clicking sound.

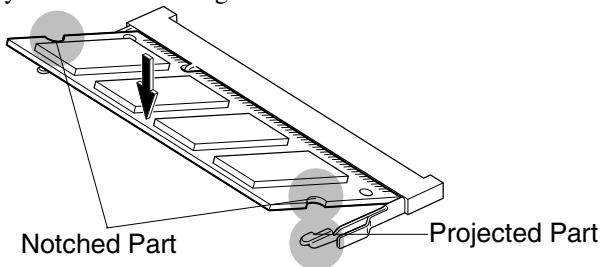

5. Replace the sheet and the memory slot cover to the computer matching the projected parts of the cover with the notched parts of the computer.

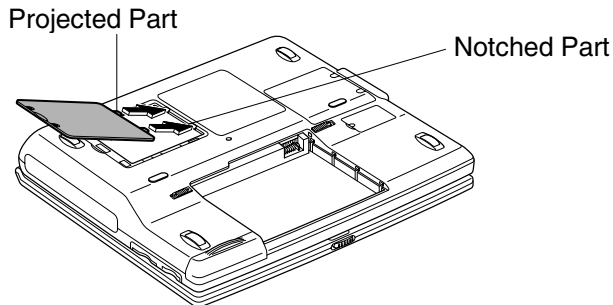

6. Tighten the screws.

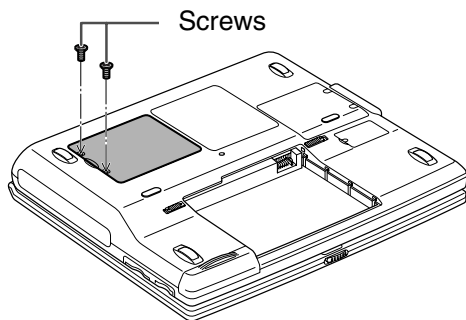

7. Replace the battery pack, turn over the computer and connect the AC adapter.
8. Turn on the computer and check the memory size by clicking *start – My computer – View system information* of *System Tasks*. Your memory size will appear at the bottom of the sentence. Share video memory size will not be included with the value.

Uninstalling the Memory Module

1. Follow steps 1-2 of *Installing the Memory Module* and turn over the sheet.
2. Slightly bend the two latches outward until the memory module is released.

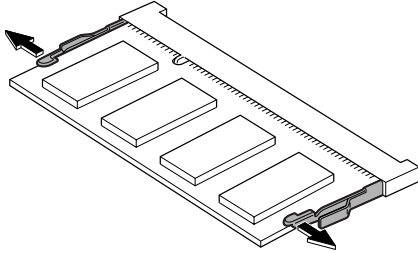

3. Remove the memory module and follow steps 5-8 of *Installing the Memory Module*.

Maintenance and Care

This section provides you with information on how to maintain the computer in excellent working condition.

Replacing Backup Battery



- *Danger of explosion if battery is incorrectly replaced. Replace only with the same or equivalent type recommended by the equipment manufacturer.*
- *Discard used batteries according to manufacturer's instructions.*

Your computer is equipped with a backup battery, which will keep the information of the Setup Utility, etc safe. If you see the message *Press F1 to Continue, Del to Load CMOS default*, replace the backup battery with a new one. A new backup battery can be purchased from your local dealer.

1. Turn off the computer, and remove the AC adapter, the battery pack and peripheral devices. See Chapter 3 for removing the battery.



Make sure to turn off your computer and remove the AC adapter and the battery pack. Otherwise the computer may malfunction.

2. Loosen the screw and remove it.

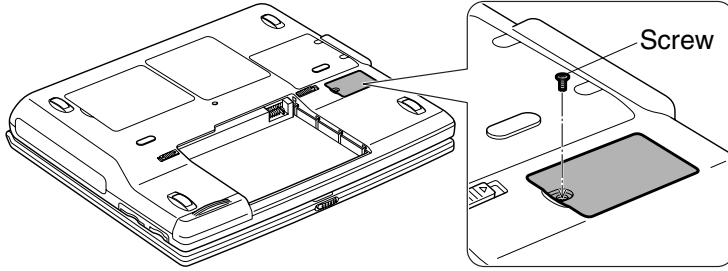

3. Lift up the cover softly and place it next to the socket.

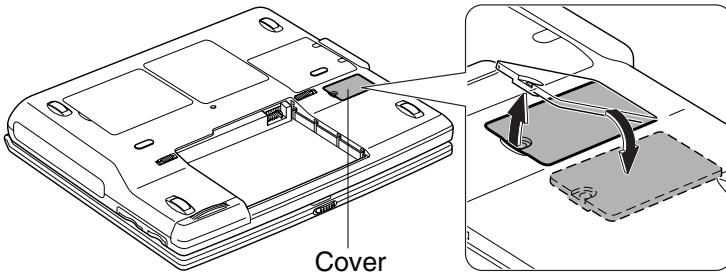

Make sure to gently remove the cover, not with great force. The backup battery connected with the computer by the cable is attached to the back of the cover.

4. Unplug the cable pulling in a straight line from the computer.

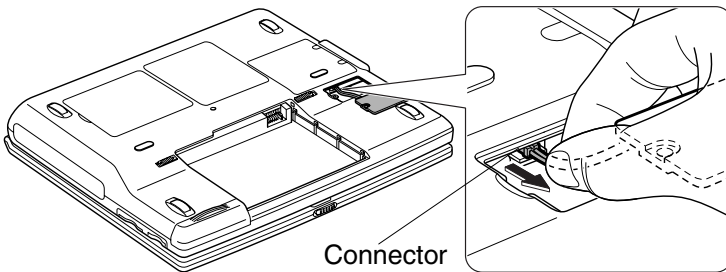

Make sure to hold the part as near to the connector of the cable as possible when pulling out the cable.

5. Remove the backup battery out of the cover by pulling it out in the arrow direction.

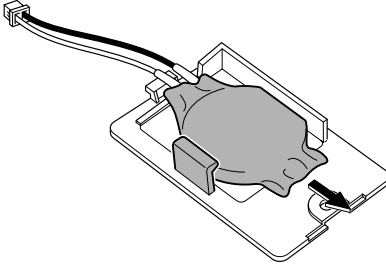

6. Set a new backup battery into the cover.

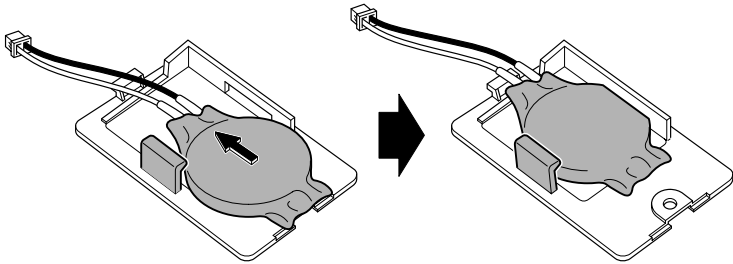

7. Connect the cables of the battery to the computer.

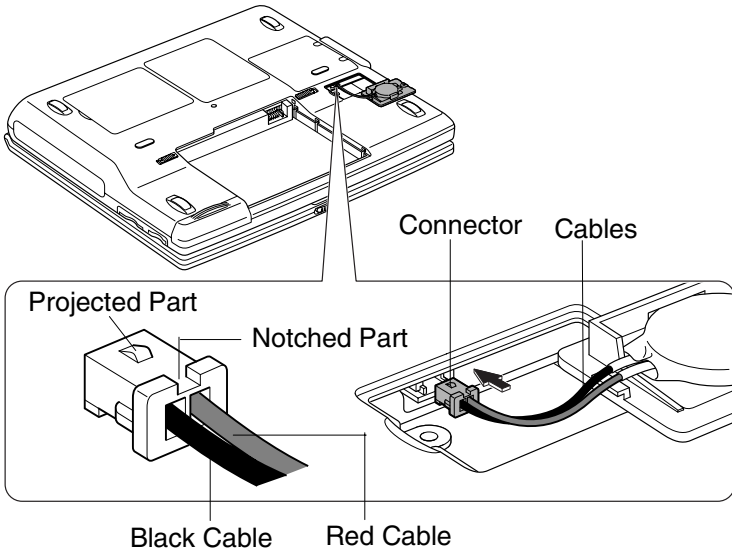

Make sure to connect the cables with the projected part and the notched part of the cable connector face up. Otherwise, the computer and the battery may be damaged.

8. Replace the backup battery box cover to the computer.

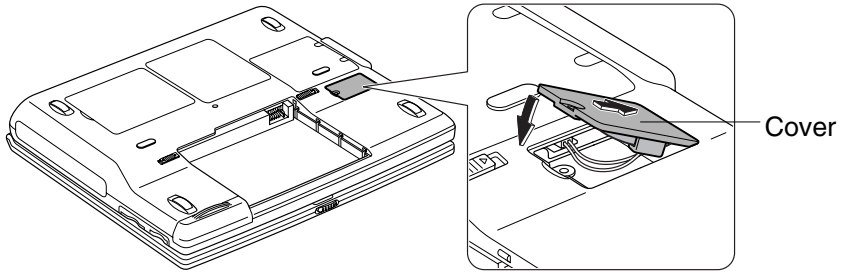

9. Tighten the screw.

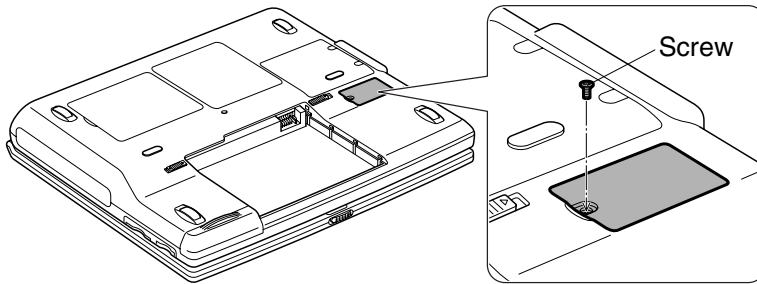

10. Insert the battery pack and turn over the computer.
11. Connect the AC adapter and turn on the computer.
12. If you see the message *Press F1 to Continue, Del to Load CMOS defaults*, press **Delete** key. The system starts.
13. Double-click the time appearing on the right of the taskbar.
14. Set the time and date in *Date and Time Properties* dialog box and click *OK*.
15. Close the dialog box.

Using a Security Cable

You can connect a security cable to the security slot on the rear side of your computer to prevent theft.

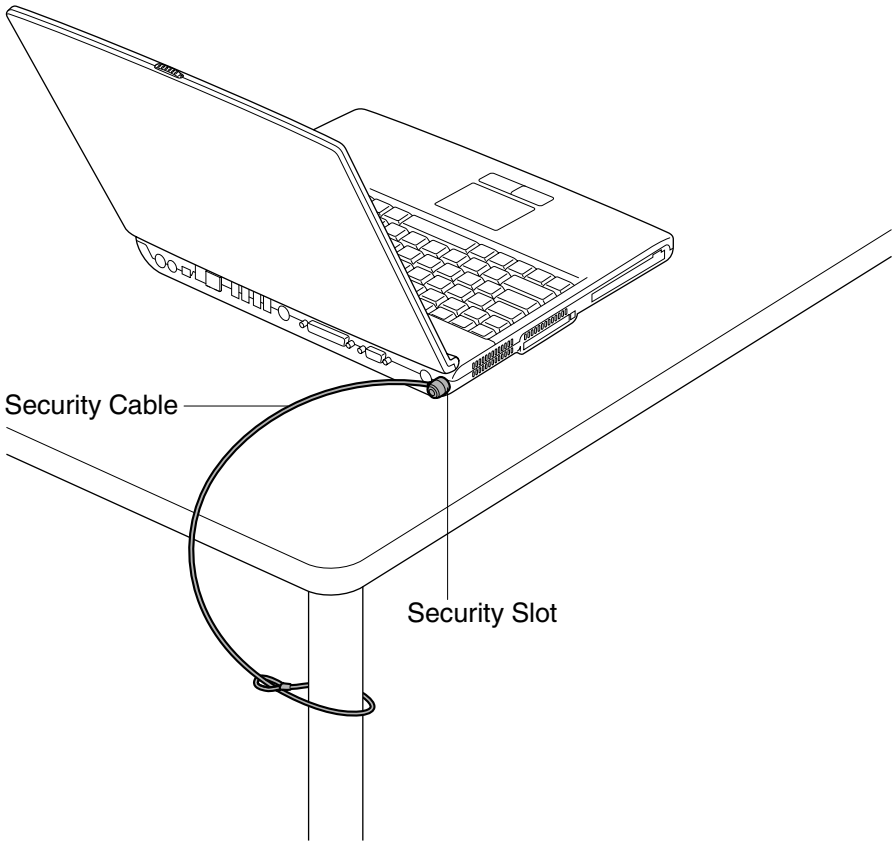

Cleaning the Computer

Cabinet

Apply a small amount of mild cleaning solution to a dry, lint-free cloth and wipe the cabinet with the cloth.



- *Never clean the computer while it is powered on.*
 - *Do not use alcohol, benzene, thinner or other strong chemical agents that may damage the cabinet.*
-

Screen

The surface of the screen may become smeared and accumulate dust during use. Avoid touching the screen with your fingers when using the system. Gently wipe the surface of the screen with a soft cloth that has been dipped in a mild detergent solution and squeezed dry.

Glide Pad

Wipe the glide pad with a soft, dry cloth.

Ventilation Openings

Dust on the ventilation openings may cause overheating of the computer. Wipe the ventilation openings with a soft, dry cloth.

Traveling with the Computer

This computer is designed for portability. For safety and convenience when traveling, please follow these guidelines.

- Before traveling, back up your data on external media.
- Do not carry the computer powered on. This may result in loss of data and/or damage to the hard disk drive.
- Make sure the display cover is closed before traveling.
- Disconnect the AC adapter from the computer.
- Fully charge the standard battery pack and bring the AC adapter and the AC power cord with the computer.
- Avoid sudden shocks or extreme vibration.

Troubleshooting

This chapter describes how to troubleshoot computer problems.

Common Problems

Problems with your computer can be caused by something as minor as an unplugged power cord or as major as a damaged hard disk drive. The information in this troubleshooting section is designed to help you find and solve minor problems. If you still have a problem after trying all the suggested remedies in this chapter, contact your dealer.

The problems that you might encounter can be divided into two basic categories: hardware and software. Hardware problems can be further divided into being of an electrical or a mechanical nature. You will know you have a hardware problem if, for example, the screen is blank, or the computer cannot recognize the disk drives.

Software problems can occur at several levels. Both your operating system and your software application programs are capable of generating errors and error messages. If you encounter a software error, try to determine if the error message is from your operating system or from an application program, and refer to the appropriate manual for possible remedies.

You can also refer to the Windows XP manual or Windows Help program to solve the problem. To access the Help program, Click *start – Help and Support*. It also gives you Troubleshooting tips and an Index.

Successful troubleshooting is the result of careful observation, deductive reasoning, and an organized approach to solving the problem. If you encounter a problem, begin by performing a careful visual inspection. Check the exterior of the computer first. If no lights are displayed, check the battery charge or power outlet, the plug and power cord, and any power switches that may affect your computer. If the computer has been connected to any peripheral devices, look for loose or disconnected cables. You may also need to check the fuses and breakers in your electric box. A few common problems and suggested solutions are presented in the examples which follow.

Trouble when Starting

Question: Why doesn't the power indicator or the battery status indicator turn on?

- Make sure the AC adapter is correctly connected to the AC adapter jack of your computer.
- Make sure the AC power cable is correctly connected to a live wall outlet. Connect another electric equipment to the wall outlet and check whether it is live or not.
- Make sure the battery pack is correctly installed and charged.
- If the battery pack is discharged, connect the AC adapter.
- If all the steps above failed, follow the instructions on *Why doesn't the keyboard or the glide pad function?*

Question: Why do I get the message *Invalid system disk*?

- You may have inserted a non-bootable disk in the floppy disk drive (either a defective disk or one without an installed operating system). Remove the disk.

Question: Why can't I boot from the floppy disk?

- Check whether the floppy disk set to the floppy disk drive contains a system disk.
- Check whether *Floppy Disk Drive* is selected in *1st Boot Device* in *Boot Sequence* of the *Main* menu of the Setup Utility.

Question: Why do I get the message *Press<F1> to continue, Del to load CMOS defaults*?

- The setting of the Setup Utility is deleted. Press **Delete** to start the system and set time and date correctly.
- If you often see the message, the backup battery has no capacity left. Replace the backup battery referring to the steps in *Replacing Backup Battery* of *Appendixes*.

Question: Why do I get the message *Press ‘H’ to retry Hard Disk, any other key for floppy?*

- If you cancel the re-installation on the way, you will see the message above. Restart re-installation from the beginning of *Re-installation Instructions* procedures of the provided Supplement and format the entire hard disk (both C: and D: drives) this time.

Trouble with Display

See also the *Display* section of Chapter 2 and 4.

Question: Why is the screen blank?

- Press any key to see if any power management feature has turned off the screen to save power.
- See the power indicator to check whether the computer is turned on.
- If you are using a battery pack, make sure it is correctly installed and has a charge remaining.
- Make sure the LCD screen is selected as the display by pressing **Fn+F5**.
- Check whether the display is on by pressing **Fn+F11**.
- If you still have the problem after trying the above, follow the steps in *Why doesn't the keyboard or the glide pad function?*

Question: Why does the external monitor display nothing or the image on it distorted?

- Confirm the monitor is turned on.
- Confirm the monitor is connected correctly.
- If the television set is connected to the computer, disconnect it.
- Make sure the external monitor is selected as the display by pressing **Fn+F5**.
- If you use **Fn+F5** to change the display, the image may be distorted. Press **Fn+F5** again to return the previous display and use *Display Properties* dialog box to change it again.
- Make sure the value of the *Screen resolution* in the *Settings* tab of the *Display Properties* is as same as that of the external monitor resolution or lower.
- Make sure the external monitor is not near any electric devices having strong magnetic fields such as a TV set or radio.
- Do not share an outlet with a TV set or radio.

Question: Why can't I change the display with Fn+F5 keys?

- When playing the animation or game, **Fn+F5** key combination may not work. Close the currently running application.
- When running DOS in the full screen mode, **Fn+F5** key combination may not work.
- Use *Display Properties* dialog box to change it.
- If you connect the television set, **Fn+F5** key combination does not work. Use *Display Properties* dialog box to change it.

Question: Why does the television set display nothing or the image on it distorted?

- Confirm the television set is turned on.
- Confirm the television set is connected correctly.
- If an external monitor is connected to the computer, disconnect it.
- Confirm *TV SYSTEM* in *Advanced* menu of Setup Utility is set to the appropriate type.

Question: How can I set the external monitor or the TV set selectable in *Display Properties* dialog box?

- Confirm the external monitor or the television set is turned on.
- Confirm the external monitor or the television set is connected correctly.
- Open *Driver Mode Setting* dialog box (refer to Chapter 2 or Chapter 4) and uncheck *Auto* of *Driver Mode*. Be sure to check *Auto* again before you turn off the computer.

Trouble with Keyboard/Glide Pad**Question: Why doesn't the keyboard or the glide pad function?**

- Follow the steps below:
 1. Press **Ctrl+Alt+Delete** simultaneously and follow the message on the screen.
 2. If step1 does not work, press the power switch for more than four seconds to turn off the system. Ten seconds later, turn the computer on.

3. If you still cannot turn off the system with the power switch, press the reset switch on the bottom of your computer to turn off the system (refer to page 2-3). Ten seconds later, turn on the computer by pressing the power button.

Question: Why does the glide pad malfunction?

- The surface of the glide pad or your palm may be moist or dirty and greasy. Wipe the glide pad with a soft, dry cloth.
- Confirm *Internal Pointing Device* is enabled in *Advanced* menu of the Setup Utility.

Trouble with Floppy Disks

Question: Why can't I use a floppy disk?

- Confirm the floppy disk is inserted correctly.
- Confirm the drive and file name are correct.
- The floppy disk may not be formatted or could be corrupted. Format the disk or use another disk.
- If you cannot write to a floppy disk, the disk may be write-protected. Eject the disk and ensure that the write-protect tab covers the detection hole.
- If you cannot write to a floppy disk, the disk may be full. Use another disk.

Trouble with the Hard Disk

Question: Why can't I read or write data to/from the hard disk?

- Confirm the drive and file names are correct.
- Confirm the hard disk has sufficient free space.

Trouble with the CD/DVD

Question: Why does not the drive open?

- Confirm the computer is turned on.

- If the computer is turned off, insert a fine rod into the drive tray ejection hole.

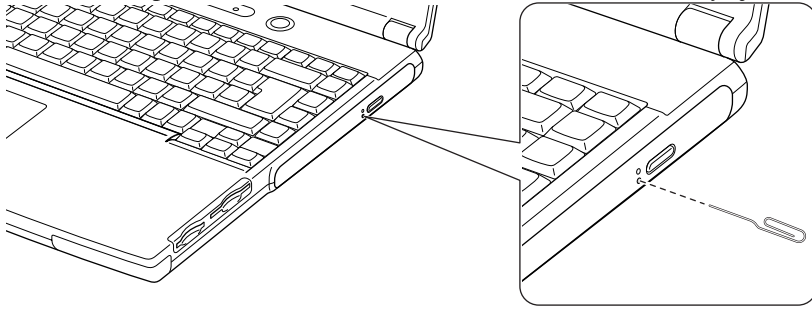

Question: Why can't I read data from a disk or play files?

- Confirm the disk is inserted correctly.
- Confirm the drive and file names are correct.
- Confirm the disk is not stained or scratched.
- Confirm the disk or files are supported.

Question: Why doesn't the DVD movie play smoothly?

- Ensure to use AC power.
- Set back the screen resolution, color quality, and screen refresh rate to the default value of 1024x768, 16bit, and 60Hertz.

Question: Why isn't the optical drive recognized?

- If the computer is turned on with some kind of DVD disks inserted in the drive, the drive may not be recognized. In this case, turn off the computer and open the disk tray by the way on *Question: Why does not the drive open?* on the previous page. Remove the disk from the drive; then turn on the computer again.

Trouble with Communication

Question: Why can't I communicate through the built-in modem?

- Confirm the telephone line is properly connected to the modem jack.
- Confirm the dial setting (pulse or tone) of Windows XP and/or communication software are matched with the telephone line.

- If you set your connection status using *New Connection Wizard*, check *Use dialing rules* in the *Properties* dialog box of that connection status. Refer to *Internet Connection* of Chapter 5.
- Confirm the country/region setting is appropriate.
- Confirm the network configuration is appropriate.
- Confirm the user name or password is correct.
- Confirm the COM port in the communication software is set appropriately.
- Turn off the power management in the Windows.
- If an unusual device is attached to the line you are connecting to, the modem may not function properly. Remove the device or contact the dealer of the device.
- If your computer is connected to a PBX, consult the PBX maintenance staff or its service company. If the electric characteristics of your PBX are different from those of a regular analog line, the modem will not function properly. If you connect the modem to a digital PBX, both the modem and the PBX may be damaged.

Question: Why is the communication speed so slow?

- Close the applications currently opened.
- Try to connect another ISP (Internet Service Provider), or try to connect in some other time.

Question: Why can't I access the LAN?

- Confirm the cable is properly connected to the LAN jack and the network hub.
- Confirm the network configuration is appropriate.
- Confirm the LAN driver is enabled in *System Properties* dialog box. Click *Hardware* tab; then *Device Manager*. Double-click *Network adapters*, then, *SiS 900-Based PCI Fast Ethernet Adapter*, and in *General* tab, confirm *Use this device(enable)* is selected in *Device usage*.
- Confirm the user name or the password is correct.

Question: How can I detect the MAC address?

- Follow the instructions below:
 1. Click *start – All Programs – Accessories – Command Prompt*.
 2. Type `ipconfig/all`; then, press **Enter**. The information about IP appears.

3. See the numbers of *Physical Address* in *Ethernet adapter Local Area Connection* section (for LAN) or *Ethernet adapter Wireless Network Connection* section (for Wireless LAN /for a built-in wireless LAN model only).
4. Type `exit`; then, press **Enter**.

Trouble with Peripherals

Question: Why don't peripheral devices function?

- Confirm they are correctly connected to your computer.
- Confirm they are Windows XP compliant.
- Confirm drivers necessary for the devices are installed.

Question: Why can't I print?

- Make sure the printer is turned on.
- Check whether the computer and the printer are connected correctly.
- Check whether the printer is ready to print.
- Check whether the printer has enough paper.
- Check whether the printer driver is installed.
- Click *start* – *Control Panel*. Click *Printers and Other Hardware*; then, *Printers and Faxes*. If Classic view is selected, double-click *Printers and Faxes* icon. Confirm your printer is installed here. If not, click *Add a printer* to install your printer.
- See also the Windows Help.

Question: Why don't peripheral devices function correctly?

- Set *System standby* and *System hibernates* to *Never* in *Power Options Properties* dialog box. If this does not work, set *Turn off hard disks* to *Never*.
- Confirm they are Windows XP Home compliant.
- Confirm drivers necessary for the devices are installed.

Other Troubles

Question: Why is the battery pack discharged so quickly?

- Condition the battery pack.

Question: Why is the date and/or time incorrect?

- Correct the date and time in Windows XP. Double-click the time appearing on the taskbar and set them in *Date and Time Properties* dialog box.

Question: Why can't I use a hardware device?

- Make sure the hardware device is not disabled.
 1. Click *start– Control Panel*.
 2. Click *Performance and Maintenance*; then, *System*. If Classic view is selected, double-click *System* icon.
 3. Click *Hardware* tab; then, *Device Manager*.
 4. Double-click the device you cannot use.
 5. Confirm *Use this device (enable)* is selected in *Device usage*.

Question: Why can't I produce sound?

- Press **Fn+F4** to increase the output volume.
- Double-click the speaker symbol on the taskbar and check the Windows volume. If you cannot find the icon, click *start – Control Panel*. Click *Sounds, Speech, and Audio Devices*; then, *Sounds and Audio Devices*. If Classic view is selected, double-click *Sounds and Audio Devices* icon. Check the box of *Place volume icon in the taskbar*.

Question: Why can't I turn off the computer?

- Follow the instructions on *Why doesn't the keyboard or the glide pad function?*

Question: Why the computer is so hot?

- When charging the battery pack, its surrounding area or the front of the keyboard may become hot, but this is not a problem.

Question: Why can't I record the sound from the microphone?

- Follow the instructions below:
 1. Double-click the speaker icon on the taskbar.
 2. Click *Options* and select *Properties*.
 3. Select *Recording* in *Adjust volume for*.
 4. Confirm *Microphone* is checked in *Show the following volume controls*; then, click *OK*.
 5. Close *Recording Control* dialog box.

Index

A

AC adapter
connecting, 1-3
using, 2-2

Account
creating, 2-24
switching, 2-24

Audio
connecting audio equipment, 4-5
connecting headphone, 4-6
connecting microphone, 4-7
connecting speakers, 4-5
controlling output volume, 2-21

B

Backup battery, A-4
Battery pack
changing, 3-4
charging, 3-2
checking level, 3-2
conditioning, 3-4
indicator, 2-2, 3-3
installing, 1-1
low battery indication, 3-3

C

Cleaning
computer, A-8
CD

handling, 2-15
inserting, 2-15
removing, 2-17
troubleshooting, T-5
CD-R/RW, 2-17

D

Display
changing brightness, 2-22

changing number of colors, 2-22
changing resolution, 2-22
switching the display, 2-6, 4-4
troubleshooting, T-3
turning off, 2-6

DVD-ROM

LCD optimization, 2-19
parental control, 2-19
playing, 2-18
region code, 2-18
troubleshooting, T-5

E

External monitor
connecting, 4-3
disconnecting, 4-3
switching the display, 2-6, 4-4

F

Floppy disk
formatting, 2-9
handling, 2-8
inserting, 2-8
removing, 2-9
troubleshooting, T-5
Floppy disk drive
troubleshooting, T-5

G

Glide pad
changing configuration, 2-5
clicking and double-clicking, 2-5
drag and drop, 2-5
scroll, 2-5
troubleshooting, T-4

H

- Hard disk drive
 - troubleshooting, T-5

I

- IEEE 1394 device
 - connecting, 4-12
 - disconnecting, 4-13
- Indicators
 - battery status, 2-2, 3-3
 - power, 1-4, 2-2
 - status, xiv

K

- Keyboard
 - function keys, 2-6
 - special keys, 2-6
 - troubleshooting, T-4
 - windows key, 2-6

L

- LAN
 - connecting to network, 5-4
 - troubleshooting, T-7

M

- Memory module
 - installing, A-1
 - uninstalling, A-4
- Modem
 - configuring, 5-2
 - connecting to telephone line, 5-2
 - troubleshooting, T-6

O

- Optical drive
 - troubleshooting, T-5

P

- Passwords
 - changing, 2-26, 6-6
 - deleting, 2-26, 6-6

- setting, 2-25, 6-5

PC cards

- ejecting, 4-10
- inserting, 4-9

Peripherals

- audio equipment, 4-5
- connecting guidelines, 4-1
- external monitor, 4-3
- headphones, 4-6
- IEEE 1394 device, 4-12
- microphone, 4-7
- PC cards, 4-9
- printer, 4-11
- speakers, 4-5
- television set, 2-19
- troubleshooting, T-8
- USB device, 4-8

Power

- choosing AC or battery, 2-1
- indicator, 1-4, 2-2

Power management

- disabling, 3-10
- stopping power supply to display, 3-7
- stopping power supply to hard disk, 3-7
- system hibernate, 3-8
- system standby, 3-8

Printer, 4-11

R

Resetting

- power switch, 2-3
- reset switch, 2-3

S

Setup utility

- advanced menu, 6-4
- entering and exiting, 6-2
- exit menu, 6-7
- main menu, 6-3
- running, 6-1
- security menu, 6-5

SD memory card

- ejecting, 2-11
- inserting, 2-10

Security cable, A-8

Smart media card

- ejecting, 2-13
- inserting, 2-12

S/PDIF compliant digital audio, 4-5

Status indicators, xiv

System hibernate

- about, 3-8

- generating conditions, 3-9

- resuming from, 3-8

- supporting, 3-9

System standby

- about, 3-8

- generating conditions, 3-9

- resuming from, 3-8

T

Television set, 2-19

Troubleshooting

- common problems, T-1

- communications, T-6

- display, T-3

- floppy disk drive, T-5

- hard disk drive, T-5

- keyboard or glide pad, T-4

- LAN, T-7

- optical drive, T-5

- peripherals, T-8

- reference, T-1

U

USB device, 4-8

W

Windows

- first-time setup, 1-5

- properties dialog boxes, 1-5

SHARP CORPORATION